

Contents

1	FEATURES.....	1
2	PREPARATION.....	2
	2.1 Precaution.....	2
	2.2 Nomenclature.....	3
	2.3 Unpacking and Store of Instrument.....	5
	2.4 Setting the Instrument Up.....	5
	2.5 Battery Remove & Insertion, Information and Recharging.....	6
	2.6 Reflector Prisms.....	7
	2.7 Mounting and Dismounting Instrument from Tribrach.....	8
	2.8 Eyepiece Adjustment and Object Sighting.....	9
	2.9 Turn On and Off.....	9
	2.10 How To Enter Alphanumeric Characters.....	10
3	FUNCTION KEY AND DISPLAY.....	12
	3.1 Operating Key.....	12
	3.2 Function Key.....	13
4	INITIAL SETTING.....	16
	4.1 Setting of Temperature, Air Pressure and Prism Constant.....	16
	4.2 Setting of Temperature and Atmospheric Pressure.....	16
	4.3 Setting of Atmospheric Correction.....	17
	4.4 Atmospheric Refraction and Earth Curvature Correction.....	19
	4.5 Setting of Prism Constant.....	20
	4.6 Setting of Minimum Reading.....	20
	4.7 Setting of Auto Cut-Off.....	21
	4.8 Setting of Vertical Angle Tilt Correction.....	22
	4.9 Setting of LCD Contrast.....	23
	4.10 Setting of Instrument Constant.....	23
5	ANGLE MEASUREMENT.....	25
	5.1 Measuring Horizontal Angle Right and Vertical Angle.....	25
	5.2 Switching Horizontal Angle Right/Left.....	26
	5.3 Setting of Horizontal Angle.....	26
	5.3.1 Setting by Holding the Angle.....	26
	5.3.2 Setting Horizontal Angle from the Keys.....	27
	5.4 Vertical Angle Percent Grade (%)Mode.....	27
	5.5 Buzzer Sounding for Horizontal Angle 90° Increments.....	28
	5.6 Compasses (Vertical Angle).....	29

6	DISTANCE MEASUREMENT.....	30
	6.1 Setting of the Atmospheric Correction.....	30
	6.2 Setting of the Correction for Prism Constant.....	30
	6.3 Distance Measurement (Continuous Measurement).....	30
	6.4 Distance Measurement (N-time Measurement/Single Measurement)	31
	6.5 Fine Mode/Track Mode.....	33
	6.6 Stake Out (S.O.).....	33
	6.7 Offset Measurement.....	35
	6.7.1 Angle Offset.....	35
	6.7.2 Distance Offset Measurement.....	37
	6.7.3 Plane Offset Measurement.....	39
	6.7.4 Column Offset Measurement.....	41
7	COORDINATE MEASUREMENT.....	44
	7.1 Execution of Coordinate Measurement.....	44
	7.2 Setting Coordinate Values of Occupied Point.....	46
	7.3 Setting Height of the Instrument.....	47
	7.4 Setting Height of Target (Prism Height).....	48
8	SPECIAL MODE.....	50
	8.1 Surveying Program Mode (PROGRAMS).....	50
	8.1.1 Remote Elevation Measurement (REM)	50
	8.1.2 Missing Line Measurement (MLM)	53
	8.1.3 Setting Z Coordinate of Occupied Point	57
	8.1.4 Area Calculation.....	61
	8.1.5 Point to Line Measurement.....	64
	8.2 Setting the GRID FACTOR	66
	8.3 Setting Illumination of Display and Cross Hairs.....	67
9	DATA COLLECTION.....	69
	9.1 Operation procedure.....	70
	9.2 Preparation.....	70
	9.2.1 Selecting a File for Data Collection.....	70
	9.2.2 Selecting a Coordinate File for Data Collection.....	71
	9.2.3 Occupied Point and Backsight Point.....	72
	9.2.4 Measuring and Memorizing the Data.....	75
	9.3 Data Collect Offset Measurement Mode.....	79
	9.3.1 Angle Offset.....	79
	9.3.2 Distance Offset Measurement.....	81
	9.3.3 Plane Offset Measurement.....	83
	9.3.4 Column Offset Measurement.....	85

9.4	Editing PCODE Library [PCODE INPUT]	88
9.5	Setting Parameter of Data Collection.....	89
10	LAYOUT	90
10.1	Setting Parameter of Data Collection.....	91
10.2	Preparation.....	91
10.2.1	Setting the GRID FACTOR.....	91
10.2.2	Selecting Coordinate Data File.....	93
10.2.3	Setting Occupied Point.....	94
10.2.4	Setting Backsight Point.....	96
10.3	Executing A Layout.....	98
10.4	Setting A New Point.....	100
10.4.1	Side Shot Method.....	100
10.4.2	Resection Method.....	103
11	MEMORY MANAGEMENT MODE.....	109
11.1	Display Internal Memory Status.....	110
11.2	Searching Data.....	110
11.2.1	Measured Data Searching.....	111
11.2.2	Coordinate Data Searching.....	113
11.2.3	PCODE LIBRARY Searching.....	114
11.3	File Maintenance.....	114
11.3.1	Renaming a File.....	115
11.3.2	Searching Data in a File.....	116
11.3.3	Deleting a File.....	117
11.4	Coordinate Data Direct Key Input	117
11.5	Deleting a Coordinate Data from a File.....	118
11.6	Editing PCODE Library.....	119
11.7	Data Communication.....	120
11.7.1	Sending Data.....	121
11.7.2	Loading Data.....	122
11.7.3	Setting Parameter of Data Communication.....	123
11.8	Initialization.....	124
12	BASIC SETTING.....	126
12.1	The Items of Basic Setting.....	126
13	CHECK AND ADJUSTMENT.....	128
13.1	Plate Vial.....	128
13.2	Circular Vial.....	128
13.3	Inclination of Reticle.....	129
13.4	Perpendicularity of line of sight to Horizontal Axis (2c)	130

13.5 Vertical Index Difference Compensation.....	130
13.6 Adjustment of Vertical Index Difference (i angle) and Vertical Angle 0 Datum.....	131
13.7 Optical Plummet.....	132
13.8 Instrument Constant (K)	133
13.9 Parallel between Line of Sight and Emitting Photoelectric axis.....	134
13.10 Tribrach Leveling Screw.....	135
13.11 Related Parts for Reflector.....	135
14 SPECIFICATION.....	136
15 ERROR DISPLAYS.....	138
16 ACCESSORIES.....	140

1. FEATURES

1. Reflectorless Mode

The reflectorless function of NTS-350R series Total Station enables you to carry out long-distance and high-accuracy measurement directly towards objects of different materials and different colors, like wall of building, telegraph pole, wire, escarpment, mountain, mud, stake, etc. It's the best solution to the difficult measurement for those objects not easy to reach or even unreachable.

2. Complete Functions

NTS-350R series Total Station is provided with complete surveying programs with the functions of data record and parameter setting, and is applicable for professional and construction survey.

3. Simple Operation

The operation of NTS-350 series Total Station is very simple, easy to learn and master. The keys are comfortable to press.

4. Powerful Memory Management

The instrument adopts the program module with internal memory and can record the surveying data and coordinate data of 3000 points or only the coordinate data of 8000 points. You can manage the memory conveniently and add, delete, modify and transfer the data.

5. Auto Data Collection

With the automated data collection software, you can record the surveying data and coordinate data automatically, transfer them between the instrument and computer to realize the real digitized survey.

6. Small & Light EDM Head

The appearance and internal structure of the new Total Station has been made more scientific and reasonable design. So the EDM head becomes smaller, lighter and more convenient for survey.

7. Special Surveying Programs

Except for the basic surveying modes (angle, distance, coordinate measurement), the instrument is provided with special surveying program that can carry out REM, Angle Offset, MLM, Staking-out by distance or coordinates, Setting new point and etc. to meet the requirement of professional survey.

2. SECURITY GUIDE

Built-in EDM (Visible Laser) Instruction:

The instrument is equipped with a built-in EDM of laser unit at the level of Class 3R/III A. and can be identified via the following:

- A. An indicating label “3A Laser Instrument” and icon on the main body, above the vertical tangent and clamp screw.
- B. The Class 3R unit complies with the IEC 60825-1:2001 “RADIALZATION SECURITY OF THE LASER PRODUCT”.
- C. Continuous looking into the laser beam is particularly harmful and you requested to avoid being shooting directly to your eyes. The emitting maximum may achieve to 5 times of Class2/II when the wavelength is 400mm to 700mm.

Warning:

Continuous looking into the laser beam directly is harmful.

Precaution:

Never stare at the laser beam and collimate human beings. Reflector beam is effective measurement for the instrument.

Warning:

When the laser beam is shooting at prism, mirror, metal surface or window, the reflector laser beam is also harmful to eyes.

Precaution:

Never stare at the locations with laser reflection. When the reflectorless function is enabled for EDM, never stare beside the laser beam or prism. Collimating the prism via the telescope unit is requested only.

Warning:

Incorrect application of Class 3R laser equipment is very dangerous.

Precaution:

To avoid being hurt, you must pay particular attention to the precaution measures and keep it under control within the distance of possible danger according to standard IEC60825-1:2001.

The following is about the main part of relevant standard.

Class 3R laser product is applicable for outdoors and construction site use, to measure, fix lines, level etc.

- A. Only those users who are professionally trained and certified can install, adjust and operate such laser equipments.
- B. Relevant laser warning symbols should be easily identified within the operating range.
- C. Stop anyone staring at laser beam directly or using optical device to collimate the laser beam.
- D. In order to prevent the laser from hurting human beings, the laser beam should be blocked at the end point of working route. The laser beam must be stopped when it travels through the restricted area (* Harmful Distance *) or somebody is staying there.
- E. The working route of laser beam must be fixed higher or lower than the line of sight of human beings.
- F. The unit should be well kept when it is not working. Uncertified user is not allowed to operate it.
- G. Stop the laser beam shooting at plane mirror, metal surface, window, etc. without conscious, especially the surface of plane mirror and concave mirror.

* Harmful Distance refers to the maximum distance from the starting point of laser beam to its weakest end not harmful to human beings.

The harmful distance of built-in laser unit is 1000m (3300ft). When the operation is beyond this range and laser beam is weakened to Class 1R, direct staring at laser beam is less harmful.

3. PREPARATION

1. Never collimate the objective lens direct to sunlight without a filter.
2. Never store the instrument in high and low temperature, avoid the sudden and great change of temperature.
3. When not using the instrument, place it in the case and avoid shock, dust and humidity.
4. If there is great difference between the temperature in work site and that in store place, you should leave the instrument in the case till it fits the temperature of environment.
5. If the instrument has not been used for a long time, you should remove the battery for separated store. The battery should be charged once a month.
6. When transporting the instrument should be placed in its carrying case, it is recommended cushioned material is used around the case for support.
7. Be sure to secure the instrument with one hand when mounting or removing from the tripod.
8. Clean exposed optical parts with degreased cotton or lens tissue only!
9. Clean the instrument's surface with a woolen cloth when finished with use. If it gets wet, dry it immediately.
10. Before operating, inspect the power, functions and indications of the instrument as well its initial setting and correction parameters.
11. Unless you are a maintenance specialist, do not attempt to disassemble the instrument by yourself even if you find the instrument abnormal.
12. Never collimate the eyes with the laser beam of NTS-350R Series Total Station.

4. NOMENCLATURE

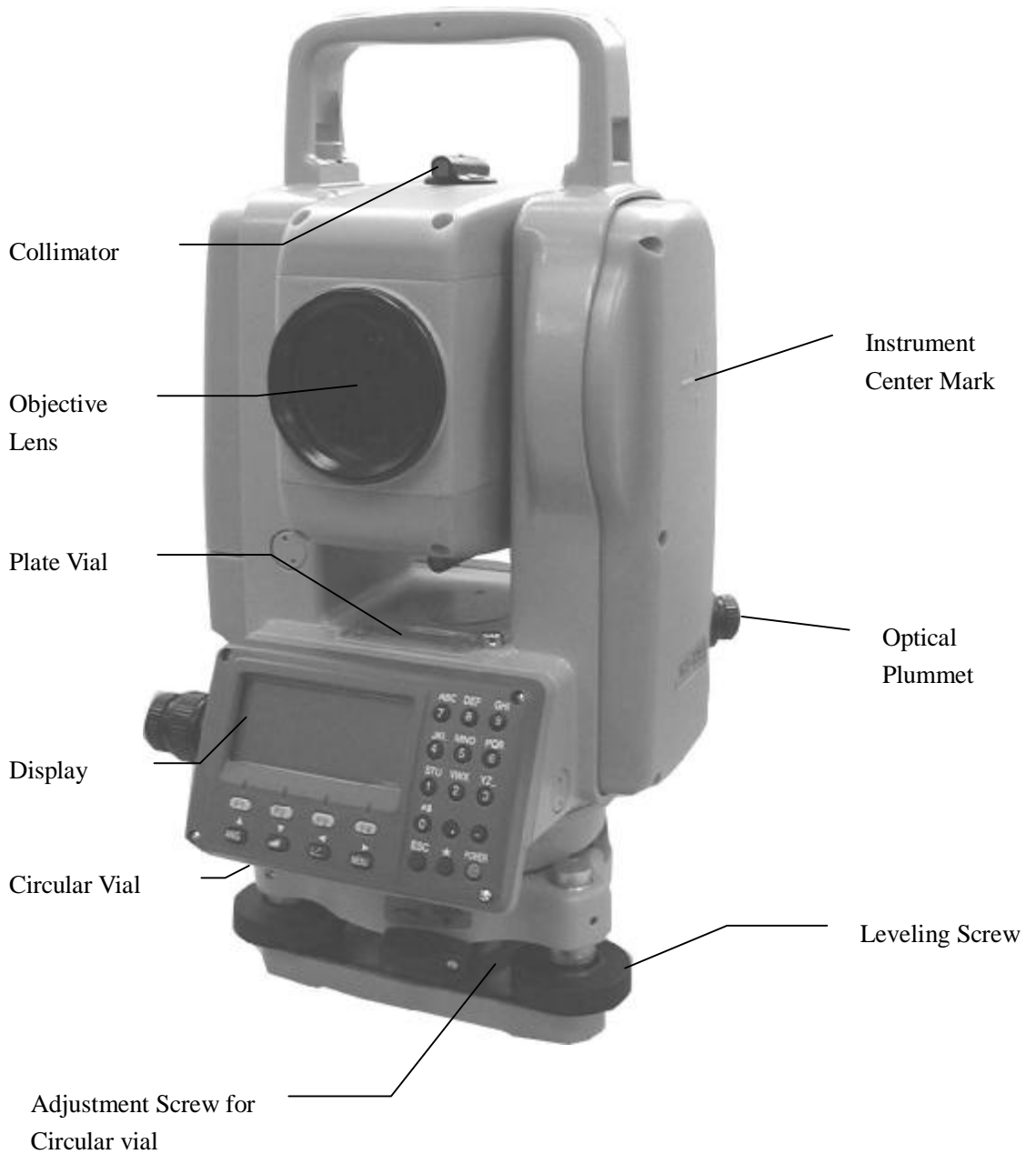

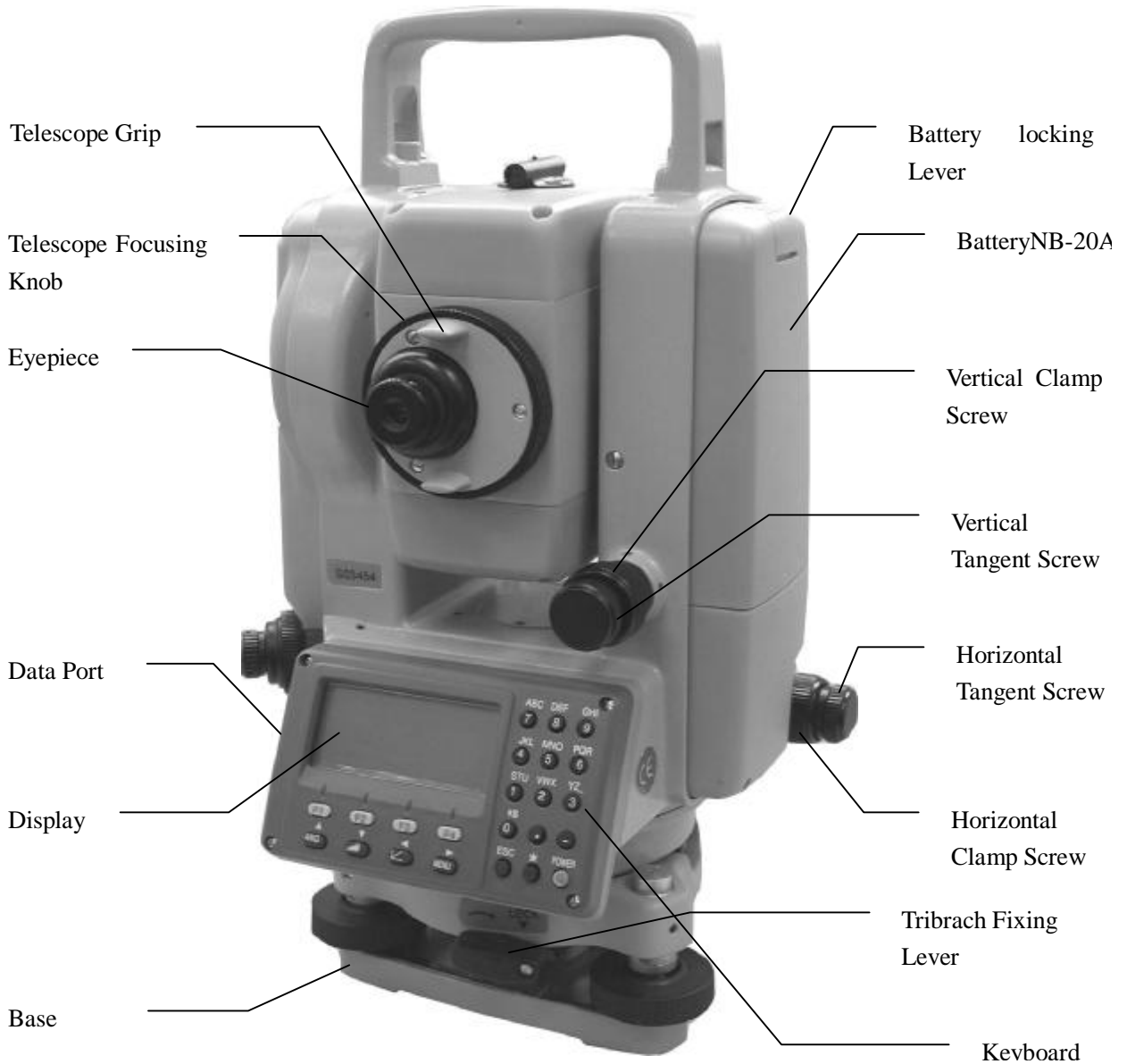

5. PREPARATION FOR SURVEYING

5.1 Unpacking and Store of Instruemnt

Unpacking of Instrument

Place the case lightly with the cover upward, and unlock the case, take out the instrument.

Store of Instrument

Cover the telescope well, place the instrument into the case with the vertical clamp screw and circular vial upward (Objective lens toward tribrach), tighten the vertical clamp screw and lock the case.

5.2 Setting the Instrument Up

Mount the instrument to the tripod. Level and center the instrument precisely to ensure the best performance. Use the tripod with a special tripod screw.

Operation Reference: Leveling and Centering the Instrument

1. Setting up the tripod

First, extend the extension legs to suitable length and tighten the screws.

2. Attaching the instrument on the tripod

Place the instrument carefully on the tripod head and slide the instrument by loosening the tripod screw. If the plumb bob is positioned right over the center of the point, slightly tighten the tripod.

3. Roughly leveling the instrument by using the circular vial

① Turn the leveling screw A and B to move the bubble in the circular vial, in which case the bubble is located on a line perpendicular to a line running through the centers of the two leveling screw being adjusted.

② Turn the leveling screw C to move the bubble to the center of the circular vial.

4. Leveling by using the plate vial

① Rotate the instrument horizontally by loosening the Horizontal Clamp Screw and place the plate vial parallel with the line connecting leveling screw A and B, and then bring the bubble to the center of the plate vial by turning the leveling screws A and B.

② Rotate the instrument 90° (100g) around its vertical axis and turn the remaining leveling screw or leveling C to center the bubble once more.

③ Repeat the procedures ①② for each 90° (100g) rotation of the instrument and check whether the bubble is correctly centered in all directions.

5.Centering by using the optical plummet

Adjust the eyepiece of the optical plummet telescope to your eyesight. Slide the instrument by loosening the tripod screw; place the point on the center mark of the optical plummet. Sliding the instrument carefully not to rotate that allows you to get the least dislocation of the bubble.

6.Completely leveling the instrument

Leveling the instrument precisely in a similar way to Step 4. Rotate the instrument and check to see that the bubble is in the center of the plate level regardless of the telescope direction, then tighten the tripod screw hard.

5.3 Battery Remove & Insertion, Information and Recharging

Battery remove & insertion

Press the top button of the battery compartment and take off the battery.

Insert the bottom of the battery into the slot in the cover and put the top button of battery into the cover until it clicks.

Battery information

HR:	170° 30' 20"		
HD:	235.343	m	
VD:	36.551	m	☰
MEAS	MODE	S/A	P1 ↓

☰----- Indicates that energy is abundant

☐----- Indicates that the battery can only be used for about 1 hour. Recharge the battery or prepare a recharged battery for use.

—----- Recharge the battery or prepare a recharged battery for use.

—Blink ---- If blinks, it is indicating that the instrument only can be used for

about 30 minutes. Stop operating and change the battery as soon as possible.

Note: ① The working time of the battery is determined by environment condition, recharging time and etc.

②The remaining energy level of battery is related to current measuring mode.

Precaution: Check the battery power condition before starting the fieldwork.

Battery Recharging

Battery should be recharged only with the charger NC-20 coming with instrument.

Remove on-board battery from instrument and connect to battery charger. When the indicator lamp on the battery charger is orange, the recharging process has begun and will be completed in about 6 hours. When charging is complete (indicator lamp turn green), remove the battery from the charger and disconnect the charger from its power source .

Battery Removal Caution

▲Before you take the battery out of the instrument, make sure that the power is turned off. Otherwise, the instrument can be damaged.

Recharging Caution:

▲The charger has built-in circuitry for protection from overcharging. However, do not leave the charger plugged into the power outlet after recharging is completed.

▲Be sure to recharge the battery at a temperature of $0^{\circ} \sim \pm 45^{\circ}$ C, Recharging may be abnormal beyond the specified temperature range.

▲When the indicator lamp does not light, even after connecting the battery and charger, either the battery or the charger may be damaged.

Storage Caution:

▲Rechargeable battery can be repeatedly recharged 300-500 times. Complete discharge of the battery may shorten its service life.

▲In order to get the maximum service life, be sure to recharge it once a month.

5.4 Reflector Prisms

When doing distance metering, a reflector prism needs to be placed at target place. Reflector systems come with single prism and triple prisms, which can be mounted with tribrach on a tripod, or mounted on a prism pole. Unique Mini prism systems allow setups at corners that are hard to reach.

Illustrated are the prisms systems which match the instrument:



5.5 Mounting and Dismounting Instrument from Tribrach

Dismounting

When necessary, the instrument can be dismounted from tribrach. Loosen the tribrach locking screw in the locking knob with a screwdriver. Turn the locking knob about 180 degree counter-clockwise to disengage anchor jaws, and take off the instrument from tribrach.

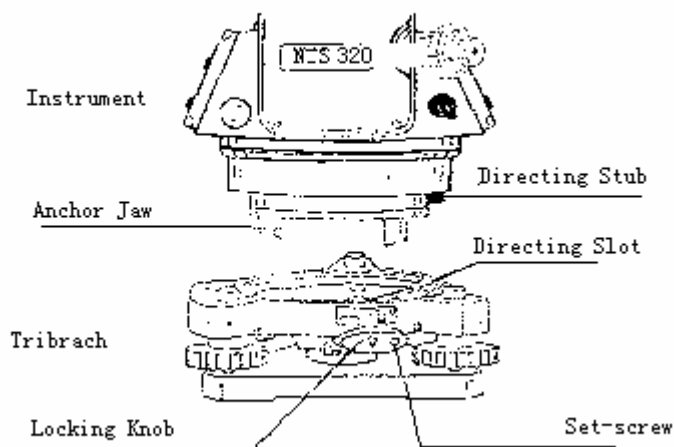

Mounting

Insert three anchor jaws into holes in tribrach and line up the directing stub with the directing slot. Turn the locking knob about 180 degree clockwise and tighten the locking screw with a screwdriver.

5.6 Eyepiece Adjustment and Object Sighting

Method of Object Sighting (for reference)

- ①Sight the Telescope to the sky and rotate the eyepiece tube to make the reticle clear.
- ②Collimate the target point with top of the triangle mark in the collimator. (keep a certain distance between eye and the collimator).
- ③Make the target image clear with the telescope focusing screw.

If there is parallax when your eye moves up, down or left, right, that show the diopter of eyepiece lens or focus is not adjusted well and accuracy will be influenced, so you should adjust the eyepiece tube carefully to eliminate the parallax.

5.7 Turn On and Off

Power

1. Be sure that the instrument leveled.
2. Turn on the power (POWER) key

Be sure there is enough energy in the display. If there is not enough energy or 'Battery empty' shown, you should replace or recharge the battery in time.

Contrast Adjustment

Be sure of the Prism Constant value (PSM) and Atmospheric Correction Value (PPM) while Power On and you can adjust the contrast.

Press F1 (↓) or F2 (↑) key to adjust the brightness and press F4 (ENTER) key to save the setting after Power Off.

*****Don't remove the battery during measuring, otherwise the data will be lost!!**

5.8 How To Enter Alphanumeric Characters

*How to select an item

[Example 1] Select INS.HT in the data collection mode

The arrow indicates an item to enter. Press [▲][▼] key to move the arrow line up or down

```
PT# ->    PT-01
ID :
INS. HT:   0.000 m
INPUT SRCH REC OCNEZ
```

Press [▼] move->INS.HT

```
PT#:      PT-01
ID :
INS . HT->    0.000 m
INPUT SRCH REC OCNEZ
```

Press **F1** key to enter Input Menu

```
PT#:      PT-01
ID :
INS . HT=_____ m
BACK ---   --- [ENT]
```

Press **1** to input '1',
press **.** to input '.',
press **5** to input '5', enter press **ENT**

Then INS. HT=1.5m

*How to enter characters

[Example 2] Input the code ‘’ of instrument poin in Data Collection Mode.

1. Move the arrow to enter an item using the [▲] or [▼] key.

```
PT#->
ID :
INS. HT:    0.000 m
INPUT SRCH REC OCNEZ
```

2. Press **F1** (INPUT) key. The arrow is changed to ‘equal’ (=).
The characters are displayed in the bottom line.

```
PT# =
ID:
INS. HT:    0.000 m
BACK SPAC NUM [ENT]
```

3. Press **F3** to swith to letter-input mode:

```
PT# =
ID :
INS. HT:    0.000 m
BACK SPAC ALPH [ENT]
```

- Note: 1) input letters when the menu displays “ALPH”;
2) input numbers when the menu displays “NUM”;
3) in case that two consecutive letters required to input are on the same soft key, press [▶] to move the cursor to the next space when inputing the second letter.

Press **STU** to input “S”,
press **MNO** three times to input “O”,
press **STU** three times to input “U”,
press [▶] to move the cursor to the next space, then press **STU** twice to input “T”,
press **GHI** twice to input “H”,
press [▶] to move the cursor to the next space and press **GHI** three times to input “P”.

* To correct a character, move the cursor to incorrect character by pressing [◀][▶] key.

6. FUNCTION KEY AND DISPLAY

6.1 Operating Key

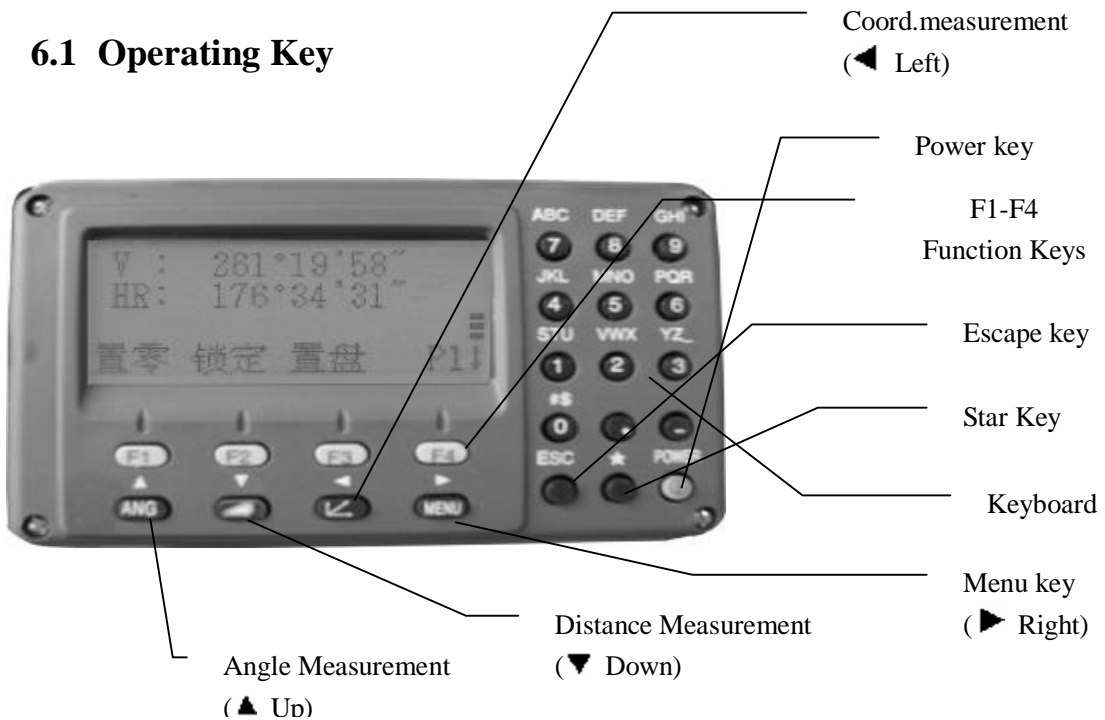

Keys: **ANG** **MENU** **ESC** **POWER** **F1** **F2** **F3** **F4**

Keys	Names	Function
	Coordinate meas.key	Coordinate measurement mode (▲ Up)
	Distance meas. key	Distance measurement mode (▼ Down)
ANG	Angle meas. key	Angle measurement mode (◀ Left)
MENU	Menu key	Switches menu mode and normal mode (▶ Right)
ESC	Escape key	Return to the measurement mode or previous layer mode. To be Data Collection mode or Layout mode directly from the normal measurement mode.
POWER	Power source key	On/off of power source
F1 - F4	Soft key (Function key)	Responds to the message displayed
0 - 9 , . , --	Number key	Input numbers, characters, point, minus, etc.
★	Star key	Enter star key mode

Display marks:

Display	Content
V%	V-angle (Gradient display)
HR	H-angle right
HL	H-angle left
HD	Horizontal distance
VD	Elevation difference
SD	Slope distance
N	N coordinate
E	E coordinate
Z	Z coordinate
*	EDM working
m	Meter unit
ft	Feet unit
fi	Feet and inch unit

6.2 Function Key

Angle measurement mode (three-page menu)

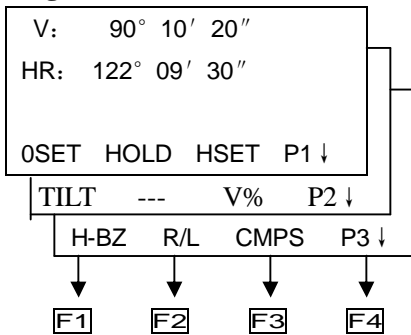

Page	Keys	Display marks	Function
P1	F1	0SET	Horizontal angle is set to 0° 0' 0"
	F2	HOLD	Hold the horizontal angle
	F3	HSET	Set a required horizontal angle by entering numerals
	F4	P1 ↓	The function of soft keys is shown on next page (P2)
P2	F1	TILT	Setting tilt correction If On. The display shows tilt correction value.
	F2	---	-----

	F3	V%	Vertical angle percent grade (%) mode
	F4	P2 ↓	The function of soft keys is shown on next page (P3)
P3	F1	H-BZ	Sets the buzzer sound for every horizontal 90°
	F2	R/L	Switches R/L rotation of horizontal angle
	F3	CMPS	Switches COMPASS ON/OFF of the vertical angle.
	F4	P3 ↓	The functions of soft keys are shown on the next page (P1)

Distance measurement mode (two-page menu)

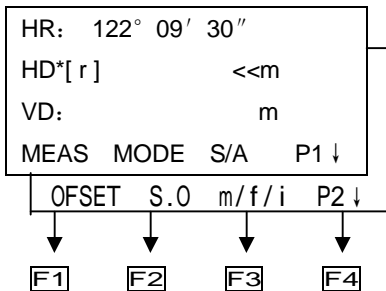

Page	Keys	Display marks	Function
P1	F1	MEAS	Start measuring
	F2	MODE	Sets a measuring mode, Fine/--/Tracking
	F3	S/A	Sets temperature, air pressure, prism constant
	F4	P1 ↓	The function of soft keys is shown on next page (P2)
P2	F1	OFFSET	Selects Off-set measurement mode
	F2	S.0	Selects Staking-out measurement mode
	F3	m/f/i	Switches meter, feet or feet and inch unit.
	F4	P2 ↓	The function of soft keys is shown on Page 1.

Coordinate measurement mode (three-page menu)

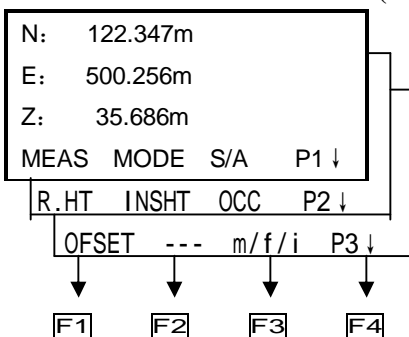

Page	keys	Display marks	Function
P1	F1	MEAS	Start measuring
	F2	MODE	Sets a measuring mode, Fine/Tracking
	F3	S/A	Sets temperature, air pressure, prism constant
	F4	P1 ↓	The function of soft keys is shown on next page (P2)
P2	F1	R.HT	Sets prism height
	F2	INSHT	Sets instrument height
	F3	OCC	Sets instrument coordinate.
	F4	P2 ↓	Shows the function of soft keys on page 3
P3	F1	OFSET	Off-set measurement mode
	F2	---	-----
	F3	m/f/i	Switches meter, feet or feet and inch unit.
	F4	P3 ↓	Shows the function of soft keys on page 1.

6.3 Star-key Mode

Press the star key and the following is displayed:

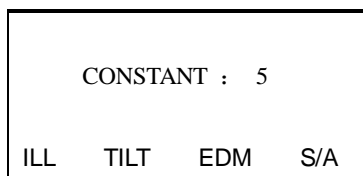

- Illumination**---Press star key, select [Illumination] by pressing **F1**, and select ON or OFF by **F1** or **F2** . or press star key to turn on/off the background light and the telescope illumination.
- Tilt**---Press the star key, select [Tilt] by pressing **F2**, and select ON or OFF by **F1** or **F3** and press **F4** to confirm.
- EDM**---Press **F3** and the following is displayed:

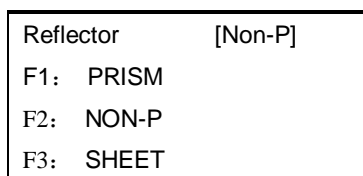

Three modes can be selected in this menu ,

F1 for using prism for reflection, **F2** for enabling the reflectorless function, **F3** for using the

reflector sheet.

Select a mode and press **ESC** to return previous menu

4. **S/A**----Pressing star key, select [S/A] by pressing **F3**, then you can go to parameter settings, like prism constant, temperature, pressure, and check the intensity of the reflector signal. Laser direction is available in the reflectorless mode.

7. INITIAL SETTING

7.1 Setting of Temperature, Air Pressure and Prism Constant

This mode will show the light intension (signal condition), atmospheric correction value (PPM) and prism constant (PSM).

Once received the relected light from the prism, the instrument will buzz. While the target is difficult to find, it will be easy to collimate with this function.

Procedure	Operation	Operating procedure	Display
(1)		Enter the first page in Distance Measurement mode.	HR: 170° 30' 20" HD: 235.343 m VD: 36.551 m MEAS MODE S/A P1 ↓
(2)	F3	②Press F3 (S/A) key, Mode is changed to Parameter Setting , Prism constant(PSM) atmospheric correction value (PPM) and relex intension (SIGNAL).	SET AUDIO MODE PSM: 0.0 ppm 2.0 SIGNAL: [] PSM PPM T-P ---
F1 to F3 are used to set Atmospheric Correction and Prism Constant Press [ESC] key to return to Normal Measuring Mode.			

7.2 Setting of Prism Constant

In the factory the prism for Total Station is set as -30. If the constant of prism used is not -30, you must do the relative setting. Once the prism constant is set, it will be saved when you turn off the instrument.

Procedure	Operation	Operation procedure	Display
-----------	-----------	---------------------	---------

(1)	F3	① Press F3 (S/A) key in Distance Measurement Mode or Coord. Measurement Mode.	<pre> SET AUDIO MODE PSM: -30.0 ppm 0.0 SIGNAL: [] PSM PPM T-P --- </pre>
(2)	F1	② Press F1 (PRISM) key	<pre> PRISM CONST. SET PRISM: 0.0 mm INPUT --- --- ENTER </pre>
(3)	F1 Enter data F4	③ Press F1 (INPUT) key to enter correction value of Prism Constant*1), press F4 to confirm and return to Setting Mode.	<pre> SET AUDIO MODE PSM: 0.0 ppm 0.0 SIGNAL: [] PSM PPM T-P --- </pre>
<p>*1) See section 5.8 “How to enter alphanumeric characters” Input range: -99.9mm to +99.9mm step length: 0.1mm</p>			

7.3 Setting of Atmospheric Correction

The infrared emitted by Total Station varies with the air temperature and pressure (in non-laser measurement mode). Once the atmospheric correction value is set the instrument will correct the distance measuring result automatically.

Correction Formula as follows:

$$F1 \text{ (fine)} = 14985518\text{Hz}$$

$$F1 \text{ (tracking)} = 149855.18\text{Hz}$$

$$F1 \text{ (tracking)} = 151368.82\text{Hz}$$

The wave length of emitting light: $\lambda = 0.865 \mu\text{m}$

The standard atmospheric condition of NTS series Total Station (that is atmospheric correction value is 0):

Air pressure: 1013hPa

Temperature: 20°C

The calculation of atmospheric correction:

$$\Delta S = 273.8 - 0.2900 P / (1 + 0.00366T) \text{ (ppm)}$$

ΔS : Correction Coefficient (Unit: ppm)

P: Air Pressure (Unit: hPa If the unit is mmHg, please convert as

$$1\text{hPa} = 0.75\text{mmHg}$$

T: temperature (Unit: °C)

Direct Setting Method of Atmospheric Correction Value

After measure the temperature and air pressure, the atmospheric correction value can be got from atmospheric correction chart or correction formula (PPM) .

Procedure	Display	Operation Procedure	Display
①	F3	Press F3 key in distance measurement or coordinate measurement mode	<pre> SET AUDIO MODE PSM: 0.0 ppm 0.0 SIGNAL: [] PSM PPM T-P --- </pre>
②	F2	Press F2 [ppm] key, show the current setting value	<pre> PPM SET PPM : 0.0 ppm INPUT --- --- ENTER </pre>
③	F1 Enter data F4	Enter atmospheric, *1) Return to setting mode.	<pre> PSM SET PPM : 4.0 ppm INPUT --- --- ENTER </pre> <pre> SET AUDIO MODE PSM: 0.0 PPM 4.0 SIGNAL: [] PSM PPM T-P --- </pre>
<p>*1) See 5.8 “How to Enter Alphanumeric Characters” Input range: -999 9PPM to +999 9 Step length: 0.1PPM</p>			

7.4 Atmospheric Refraction and Earth Curvature Correction

The instrument will automatically correct the influence of atmosphere refraction and earth curvature when measuring Horizontal Distance and Elevation Difference.

The correction refraction and earth curvature can be calculated as the following formula:

Corrected Horizontal Distance:

$$D=S * [\cos \alpha + \sin \alpha * S * \cos \alpha (K-2) / 2Re]$$

Corrected Elevation Difference

$$H= S * [\sin \alpha + \cos \alpha * S * \cos \alpha (1-K) / 2Re]$$

If not do the correction of atmospheric refraction and earth curvature, the formula of calculating the Horizontal Distance and Elevation Difference is as follows:

$$D=S \cdot \cos \alpha$$

$$H=S \cdot \sin \alpha$$

Note: In the factory the atmospheric refraction coefficient of the instrument is set as K=0.14.

For the value of K, there are two kinds, that is K=0.14 and K=0.2, also you can select Off.

K=0.14 Atmospheric refraction coefficient

Re=6370 km Radius

α (or β) The vertical angle calculated from horizon

S Slope Distance

Operation: Turn on while pressing **F4**, Set in 'F3: W-CORRECTION' of 'F3: OTHERS SET'.

7.5 Setting of Temperature and Atmospheric Pressure

Measure the surrounding temperature and air pressure in advance.

Example: temperature +25° C air pressure 1017.5

Procedure	Operation	Operating procedure	Display
(1)		Enter the Distance Measurement Mode	<div style="border: 1px solid black; padding: 5px;"> HR: 170° 30' 20" HD: 235.343 m VD: 36.551 m MEAS MODE S/A P1 ↓ </div>
(2)	F3	Enter setting Measure the surrounding temperature and air pressure in advance in Distance and Coordinate Measurement Mode.	<div style="border: 1px solid black; padding: 5px;"> SET AUDIO MODE PSM: 0.0 ppm 2.0 SIGNAL: [] PSM PPM T-P --- </div>

(3)	F3	Press F3 to carry out [T-P]	<div style="border: 1px solid black; padding: 5px;"> TEMP.& PRES. SET TEMP. -> 15.0 ° C PRES.: 1013.2 hpa INPUT --- --- ENTER </div>
(4)	Press F1 to enter temperature Press F4 to enter air pressure	Press F1 to carry out [INPUT] enter temperature and air pressure *1.Press F4 carry out [ENTER]↵.	<div style="border: 1px solid black; padding: 5px;"> TEMP.& PRES. SET TEMP. :-> 25.0 ° C PRES.: 1017.5 hpa INPUT --- --- ENTER </div>
Remarks	*1 See 2.10 “How to Enter Aiphanumeric characters” Temperature range: -30° ~+60° C (step 0.1° C) or -22~+140° F(step 0.1° F) Air pressure: 560~1066hPa (step 0.1hPa) or 420~800mmHg (step 0.1 mmHg) or 16.5~31.5inHg(step 0.1 inHg) If the atmospheric correction value calculated from the temperature and air pressure exceeds the range of ±999.9PPM, the operation will return to Step (4) automatically, and you should enter the data again.		

7.6 Setting of Maximum Measurement Range

Set the maximum measurement range of reflectorless mode.

Procedure	Operation	Operating procedure	Display
1	F3	① Press F3 (S/A) in distance measurement or coordinate measurement mode	<div style="border: 1px solid black; padding: 5px;"> SET AUDIO MODE PSM: -30.0 PPM: 0.0 SIGNAL: [] PSM PPM T-P DIS </div>
2	F4	②按 F4 (DIS) key	<div style="border: 1px solid black; padding: 5px;"> MAXIMAL DISTANCE [F1: 2000 m] F2: 5000 m </div>
Note: The maximum measurement distance is 2000m or 5000m in reflectorless mode, the surveyor can select maximum measurement range according to the fieldwork condition			

7.7 Setting of Minimum Reading

Setting of Minimum reading

Select the unit for Angle Measurement

Mode	Unit		
	degree	gon (400 gon)	mil
NTS-350	5" /1"	1mgon/ 0.2mgon	0.1mil/0.01mil

[Example] Minimum reading of angle: 5"

Operation procedure	Operation	Display
① Press MENU key Press F4 (P↓) to show Menu 2/3	MENU F4	MENU 2 / 3 F1: PROGRAM F2: PARAMETERS 1 F3: ILLUMINATION P↓
② Press F2 key	F2	PARAMETERS 1 F1: MINIMUM READING F2: AUTO POWER OFF F3: TILT P↓
③ Press F1 key	F1	MINIMUM READING F1: ANGLE
④ Press F1 key	F1	MINIMUM ANGLE [F1: 1"] F2: 5" ENTER
⑤ Press F2 (5") key, Press F4 (ENTER) key.	F2	PARAMETERS 1 F1: MINIMUM READING F2: AUTO POWER OFF F3: TILT P↓
Press ESC key to return to previous mode.		

7.8 Setting of Auto Cut-Off

If there is no key operation or ongoing measurement in 30 minutes, the instrument will cut off automatically.

Operation procedure	Operation	Display
① Press MENU key Press F4 (P ↓) to show Menu2/3	MENU F4	MENU 2 / 3 F1: PROGRAM F2: PARAMETERS 1 F3: ILLUMINATION P ↓
② Press F2 key	F2	PARAMETERS 1 F1: MINIMUM READING F2: AUTO POWER OFF F3: TILT P ↓
③ Press F2 , display original setting mode.	F2	AUTO POWER OFF F1: ON F2: OFF ENTER
④ Press F1 (ON) key or F2 (OFF) key, then press F4 (ENTER) key, return	F1 or F2 F4	MENU 2 / 3 F1: PROGRAM F2: PARAMETERS 1 F3: ILLUMINATION P ↓

7.9 Setting of Vertical Angle Tilt Correction

When the tilt sensor are activated, automatic correction of vertical angle for mislevelment is displayed. To ensure a precise angle measurement, tilt sensor must be turned on. The display can also be used to fine level the instrument. If the (TILT OVER) display appears the instrument is out of the automatic compensation range and must be leveled manually.

NTS-350R compensates the vertical angle reading due to inclination of the standing axes in the X directions.

When the instrument is on an unstable stage or a windy day the display of vertical angle is unstable. You can turn off the auto tilt correction function of vertical angle in this case.

Setting tilt correction by soft keys

To enable you to select Tilt ON/OFF function, setting is not memorized after power is off.

[Example] Setting X, Y Tilt OFF

Operation procedure	Operation	Display
---------------------	-----------	---------

①Press F4 key to get the function page 2.	F4	MENU 2 / 3 F1: PROGRAM F2: PARAMETERS 1 F3: ILLUMINATION P ↓
②Press F2 key In case ON is already selected, the display shows tilt correction value.	F2	PARAMETERS 1 F1: MINIMUM READING F2: AUTO POWER OFF F3: TILT P ↓
③Press F3 (TILT) key	F3	TILT SENSOR: [OFF] X-ON --- OFF ENT
④Press F1 (X-ON) key or F3 (OFF), then press F4 (ENT) .	F1 F4	TILT SENSOR: [X-ON] X: 0° 00' 30" X-ON --- OFF ENT

7.10 Setting of LCD Contrast

Set LCD contrast grade.

Procedure	Operation	Display
①Press MENU key, and press F4 (P ↓), enter Menu Page 2/3.	MENU F4	MENU 2 / 3 F1: PROGRAM F2: PARAMETERS 1 F3: ILLUMINATION P ↓
②Press F1 or F2 key	F3	ILLUMINATION [OFF] F1: ON F2: OFF
③Press ESC key, return.	ESC	MENU 2 / 3 F1: PROGRAM F2: PARAMETERS 1 F3: ILLUMINATION P ↓

7.11 Setting of Instrument Constant

Procedure	Operation	Display
① Turn on the instrument while pressing F1	F1 + power on	ADJUSTMENT MODE F1: V ANGLE 0 POINT F2: INST. CONSTANT
② Press F2 key	F2	INST. CONSTANT SET INST. CONSTANT : -0.5 mm INPUT --- --- ENTER
③ Input the constant *1) *2)	F1	INST. CONSTANT SET INST. CONSTANT : 1.5 mm INPUT --- --- ENTER
④ Turn off	Enter constant F4 Power off	ADJUSTMENT MODE F1: V ANGLE 0 POINT F2: INST. CONSTANT
*1) see 5.8 “How to Enter Alphanumeric characters” . *2) Press ESC key to cancel the setting.		

*Note: The constant of the instrument has been strictly set in the factory, so general the user need not to set this item. If through strict measurement (ex. in standard baseline field and by special measuring organization) it is necessary, the user can do that.

7.12 Setting of Instrument Constant in Reflectorless Mode

Setting of instrument constant in reflectorless mode is the same as 7.11 setting of instrument constant.

Procedure	Operation	Display
-----------	-----------	---------

① Turn on the instrument while pressing F1	F1 +power on	ADJUSTMENT MODE F1: V ANGLE 0 POINT F2.: INST. CONSTANT F3: NON-P. INST. CONSTANT
② Press F3	F3	NON-P. INST. CONSTANT SET INST. CONSTANT -0.5 mm INPUT --- --- ENTER
③ Input the constant *1) *2)	F1	INST. CONSTANT SET INST. CONSTANT: 1.5 mm INPUT --- --- ENTER
④ Turn off	Enter constan F4 Turn off	ADJUSTMENT MODE F1: V ANGLE 0 POINT F2.: INST. CONSTANT F3: NON-P. INST. CONSTANT
*1) See 5.8 “How to Enter Aplphanumeric characters” *2) Press ESC key to cancel the setting.		

8. ANGLE MEASUREMENT

8.1 Measuring Horizontal Angle Right and Vertical Angle

Make sure the mode is in Angle measurement.

Operating procedure	Operation	Display
① Collimate the 1st target (A)	Collimate A	V: 82° 09' 30" HR: 90° 09' 30" OSET HOLD HSET P1 ↓
② Set horizontal angle of target A at 0° 00' 00" Press the F1 (Oset) key and press the F3 (YES) key	F1 F3	H ANGLE 0 SET >OK? --- --- [YES] [NO] V: 82° 09' 30" HR: 0° 00' 00" OSET HOLD HSET P1 ↓
③ Collimate the 2nd target (B) The required V/H angle to target B will be displayed.	Collimate B	V: 92° 09' 30" HR: 67° 09' 30" OSET HOLD HSET P1 ↓

Reference: How to Collimate

1. Point the telescope toward the light. Turn the diopter ring and adjust the diopter so that the cross hairs are clearly observed.
(Turn the diopter toward you first and then backward to focus).
2. Aim the target at the peak of the triangle mark of the sighting collimator. Allow a certain space between the sighting collimator and yourself for collimating.
3. Focus the target with the focusing knob

If parallax is created between the cross hairs and the target when viewing vertically or horizontally while looking into the telescope, focusing is incorrect or diopter adjustment is poor. This adversely affects precision in measurement or survey, eliminate the parallax by carefully

focusing and using diopter adjustment.

8.2 Switching Horizontal Angle Right/Left

Make sure the mode is Angle measurement

Operation procedure	Operation	Display
① Press the F4 (↓) Key twice to get the function on page 3	F4 F4	V: 122° 09' 30" HR: 90° 09' 30" ----- 0SET HOLD HSET P1 ↓ ----- TILT REP V% P2 ↓ ----- H-BZ R/L CMPS P3 ↓
② Press the F2 (R/L)Key The mode Horizontal angle Right (HR) Switches to (HL) mode	F2	V: 122° 09' 30" HL: 269° 50' 30" ----- H-BZ R/L CMPS P3 ↓
③ Measure as HL mode .		
* Every time pressing the F2 (R/L) key, HR/HL mode switches.		

8.3 Setting of Horizontal Angle

8.3.1 Setting by Holding the Angle

Make sure the mode is angle measurement

Operation procedure	Operation	Display
① Set the required horizontal angle, using Horizontal tangent screw	Display angle	V: 122° 09' 30" HR: 90° 09' 30" ----- 0SET HOLD HSET P1 ↓
② Press the F2 (HOLD) key.	F2	H ANGLE HOLD HR = 90° 09' 30" >SET? --- --- [YES] [NO]
③ Collimate the target	Collimate	

<p>④ Press the F3 (YES) key to finish holding the horizontal angle.*1) The display turns back to normal angle measurement mode</p>	<p>F3</p>	<div style="border: 1px solid black; padding: 5px;"> <p>V: 122° 09' 30" HR: 90° 09' 30" 0SET HOLD HSET P1 ↓</p> </div>
<p>*1) To return to the previous mode, press the F4 (NO) key</p>		

8.3.2 Setting Horizontal Angle from the Keys

Make sure the mode is Angle measurement

Operation procedure	Operation	Display
<p>① Collimate the target</p>	<p>Collimate</p>	<div style="border: 1px solid black; padding: 5px;"> <p>V: 122° 09' 30" HR: 90° 09' 30" 0SET HOLD HSET P1 ↓</p> </div>
<p>② Press the F3 (HSET) key</p>	<p>F3</p>	<div style="border: 1px solid black; padding: 5px;"> <p>H ANGLE SET HR: INPUT --- [ENT]</p> </div>
<p>③ Input the required horizontal angle by using keys *1), For example: 150° 10' 20"</p>	<p>F1 150.1020 F4</p>	<div style="border: 1px solid black; padding: 5px;"> <p>V: 122° 09' 30" HR: 150° 10' 20" 0SET HOLD HSET P1 ↓</p> </div>
<p>When completed, normal measuring from the required Horizontal angle is possible *1) To enter Alphanumeric characters, see Section 5.8 "How to Enter Alphanumeric characters".</p>		

8.4 Vertical Angle Percent Grade (%) Mode

Make sure the mode is Angle measurement

Operation procedure	Operation	Display
---------------------	-----------	---------

① Press the F4 (↓) key to get the function on page 2	F4	V : 90° 10' 20" HR: 90° 09' 30" --- OSET HOLD HSET P1 ↓ TILT --- V% P2 ↓
② Press the F3 (V%) key.*1)	F3	V: -0.30% HR: 90° 09' 30" --- TILT --- V% P1 ↓
*1) Every time pressing the F3 (V%) key, the display mode switches When the measurement is carried out over ±45° (±100%) from the horizontal, the display shows<OVER>		

8.5 Buzzer Sounding for Horizontal Angle 90° Increments

When the horizontal angle falls in the range of less than ±1° of 0°, 90°, 180° or 270°, the buzzer sounds, Buzzer stops only when the horizontal angle is adjusted to 0° 00' 00", 180° 00' 00" or 270° 00' 00". This setting is not memorized after powering off.

Make sure the mode is Angle measurement

Operation procedure	Operation	Display
① Press the F4 (↓) key twice to get the function on page 3	F4 F4	V: 90° 10' 20" HR: 170° 30' 20" --- OSET HOLD HSET P1 ↓ H-BZ R/L CMPS P3 ↓
② Press the F1 (H-BZ) key the data previously set is shown	F1	H-ANGLE BUZZER [OFF] --- [ON] [OFF] --- ENTER
③ Press the F1 (ON) key or F2 (OFF) key to select the buzzer ON/OFF	F1 or F2	H-ANGLE BUZZER [ON] --- [ON] [OFF] --- ENTER

④ Press the F4 (ENTER) key	F4	<table border="1"> <tr> <td>V:</td> <td>90° 10' 20"</td> </tr> <tr> <td>HR:</td> <td>170° 30' 20"</td> </tr> <tr> <td colspan="2">0SET HOLD HSET P1 ↓</td> </tr> </table>	V:	90° 10' 20"	HR:	170° 30' 20"	0SET HOLD HSET P1 ↓	
V:	90° 10' 20"							
HR:	170° 30' 20"							
0SET HOLD HSET P1 ↓								

8.6 Compasses (Vertical Angle)

Vertical angle is displayed as shown below:

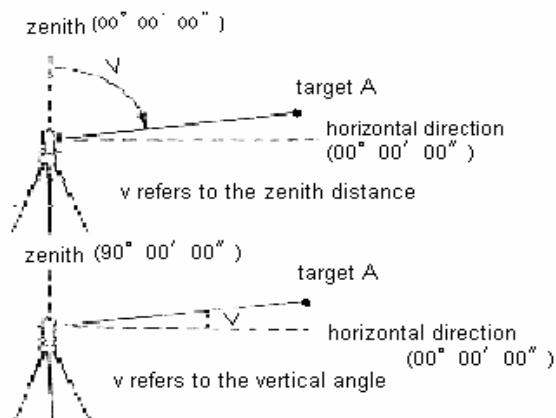

Operation procedure	Operation	Display								
① Press the F4 (↓) key twice to get the function on page 3	F4 F4	<table border="1"> <tr> <td>V:</td> <td>19° 51' 27"</td> </tr> <tr> <td>HR:</td> <td>170° 30' 20"</td> </tr> <tr> <td colspan="2">0SET HOLD HSET P1 ↓</td> </tr> <tr> <td>H-BZ</td> <td>R/L CMPS P3 ↓</td> </tr> </table>	V:	19° 51' 27"	HR:	170° 30' 20"	0SET HOLD HSET P1 ↓		H-BZ	R/L CMPS P3 ↓
V:	19° 51' 27"									
HR:	170° 30' 20"									
0SET HOLD HSET P1 ↓										
H-BZ	R/L CMPS P3 ↓									
② Press the F3 (CMPS) key *1)	F3	<table border="1"> <tr> <td>V:</td> <td>70° 08' 33"</td> </tr> <tr> <td>HR:</td> <td>170° 30' 20"</td> </tr> <tr> <td colspan="2">H-BZ R/L CMPS P3 ↓</td> </tr> </table>	V:	70° 08' 33"	HR:	170° 30' 20"	H-BZ R/L CMPS P3 ↓			
V:	70° 08' 33"									
HR:	170° 30' 20"									
H-BZ R/L CMPS P3 ↓										
*1) Every time pressing the F3 (CMPS) key, the display mode switches										

9. DISTANCE MEASUREMENT

9.1 Setting of the Atmospheric Correction





When setting the atmospheric correction, obtain the correction value by measuring the temperature and pressure. Refer to Section 7.3 “Set Atmospheric Correction”.

9.2 Setting of the Correction for Prism Constant

Prism Constant value is -30. Set correction for prism at -30. If the prism is of another manufacturer, the appropriate constant shall be set beforehand. Refer to Chapter 7.5 “Set Prism Constant”. The setting value is kept in the memory even after power is off.

9.3 Distance Measurement (Continuous Measurement)

Make sure the mode displays angle measurement

Operation procedure	Operation	Display
① Collimate the center of prism	Collimate	<div style="border: 1px solid black; padding: 5px;"> V: 90° 10' 20" HR: 170° 30' 20" H-BZ R/L CMPS P3 ↓ </div>
② Press the  key, Distance measurement starts.*1)2); The measured distances are shown *3)-*5)		<div style="border: 1px solid black; padding: 5px;"> HR: 170° 30' 20" HD*[r] <<m VD: m MEAS MODE S/A P1 ↓ </div> <div style="border: 1px solid black; padding: 5px;"> HR: 170° 30' 20" HD* 235.343m VD: 36.551m MEAS MODE S/A P1 ↓ </div>
③ Pressing the  key again, the display changes to horizontal (HR) and vertical (V) angle and slope distance (SD) *6)		<div style="border: 1px solid black; padding: 5px;"> V: 90° 10' 20" HR: 170° 30' 20" SD* 79.551m MEAS MODE S/A P1 ↓ </div>



- *1) When EDM is working, the “*” mark appears in the display.
- *2) To change mode from Fine to Coarse or Tracking, refer to section 9.5 “Fine mode/Tracking Mode/Coarse Mode”. To set the distance measurement on when the instrument is powered up, refer to Chapter 15 “Basic Setting”.
- *3) The distance unit indicator “m” (for meter), ”ft” (for feet) or “fi” (for feet and inch) appears and disappears alternatively with buzzer sounds at every renewal of distance data.
- *4) Measurement may repeat automatically in the instrument if the result is affected by shimmer etc*.
- *5) To return to the normal measuring angle mode from a distance measuring mode, press the **ANG** key.
- *6) It is possible to choose the display order (HR,HD,VD) or (V,HR,SD) for initial measuring distance mode. Refer to Chapter 15 “Basic Setting”.

9.4 Distance Measurement (N-time Measurement/ Single Measurement)

When the number of times measurement is preset, the instrument measures the distance the set number or times. The average distance will be displayed.

When presetting the number of times as 1, it does not display the average distance because of single measurement; Single measurement is set at the factory.

Make sure the mode display angle measurement.

Operation procedure	Operation	Display
① Collimate the center of prism	Collimate	V: 122° 09' 30" HR: 90° 09' 30" OSET HOLD HSET P1 ↓
② Press the  key Continuous measurement starts.*1)		HR: 170° 30' 20" HD*[r] <<m VD: m MEAS MODE S/A P1 ↓

<p>③ Press F1 (MEAS) key while continuous measuring is exceeding *2): The average value is displayed and “*”mark disappears</p> <p>While EDM is working, press F1 (MEAS) key again, the mode will be changed to continuous measuring mode.</p>	F1	<div style="border: 1px solid black; padding: 5px; margin-bottom: 10px;"> HR: 170° 30' 20" HD*[n] <<m VD: m MEAS MODE S/A P1 ↓ </div> <div style="border: 1px solid black; padding: 5px;"> HR: 170° 30' 20" HD: 566.346 m VD: 89.678 m MEAS MODE S/A P1 ↓ </div>
<p>*1) It is possible to set the measurement mode for N-times measurement mode or continuous measurement mode when the power is turned on. Refer to Chapter 15 “Basic Setting”.</p> <p>*2) For setting the number of times(N-times)in the measurement, refer to Chapter 15 “Basic Setting”.</p>		

Choose meter/feet/feet, inch unit by soft key

It is possible to change the unit for distance measurement mode by soft key.

This setting is not memorized after power off. Refer to 15 “Basic Setting” to at the initial setting (memorized after power off).

Operation procedure	Operation	Display
<p>① Press the F4 (P1 ↓) key to get the function on page 2</p>	F4	<div style="border: 1px solid black; padding: 5px;"> HR: 170° 30' 20" HD: 2.000m VD: 3.678m MEAS MODE S/A P1 ↓ OFSET S.O m/f/i P2 ↓ </div>
<p>② Every time pressing the F3 (m/f/i) key, the display unit will be changed. Every time pressing the F3 (m/f/i) key, the unit mode switches.</p>	F3	<div style="border: 1px solid black; padding: 5px;"> HR: 170° 30' 20" HD: 566.346 ft VD: 89.678 ft OFSET S.O m/f/i P2 ↓ </div>

9.5 Fine Mode/Track Mode

This setting is not memorized after power is off. Refer to Chapter 15 “Basic Setting” to set at the initial setting (memorized after power is off).

Operation procedure	Operation	Display
① Press the F2 (MODE) key from the distance measuring mode *1) The initial character (F/T/C) of set mode is displayed (F:Fine, T:Tracking, C:Coarse)	F2	<div style="border: 1px solid black; padding: 5px;"> HR: 170° 30' 20" HD: 566.346m VD: 89.678m MEAS MODE S/A P1 ↓ </div>
② Press the F1 (FINE) key, F2 (TRACK) key	F1 — F2	<div style="border: 1px solid black; padding: 5px;"> HR: 170° 30' 20" HD: 566.346 m VD: 89.678 m FINE TRACK --- F </div> <div style="border: 1px solid black; padding: 5px;"> HR: 170° 30' 20" HD: 566.346 m VD: 89.678 m MEAS MODE S/A P1 ↓ </div>
*1) To cancel the setting, press the ESC key		

9.6 Stake Out (S.O.)

The difference between the measured distance and the input stake out distance is displayed.

Measured distance-Stake out distance=Displayed value

In stake out operation, you can select either horizontal distance (HD), relative elevation (VD) and slope distance (SD.)

Operation procedure	Operation	Display
---------------------	-----------	---------

<p>① Press the F4 (↓) key in the distance measuring mode to get the function on page 2</p>	<p>F4</p>	<pre> HR: 170° 30' 20" HD: 566.346m VD: 89.678m MEAS MODE S/A P1 ↓ ----- OFSET S.O m/f/i P2 ↓ </pre>
<p>② Press the F2 (S.O) key The data previously set is shown.</p>	<p>F2</p>	<pre> STAKE OUT HD: 0.000 m ----- HD VD SD --- </pre>
<p>③ Select the measuring mode by pressing the F1, F3 key Example: Horizontal distance</p>	<p>F1</p>	<pre> STAKE OUT HD: 0.000 m ----- BACK SPAC NUM [ENT] </pre>
<p>④ Enter the distance for stake out *1)</p>	<p>Enter data F4</p>	<pre> STAKE OUT HD: 350.000 m ----- INPUT --- --- ENTER </pre>
<p>⑤ Collimate the target (Prism), measurement starts. The difference between the measured distance and the stake out distance is displayed</p>	<p>Collimate P</p>	<pre> HR: 120° 30' 20" dHD*[r] <<m VD: m INPUT --- --- ENTER </pre>
<p>⑥ Move the target until the difference becomes 0m.</p>		<pre> HR: 120° 30' 20" dHD*[r] 25.688 m VD: 2.876 m MEAS MODE S/A P1 ↓ </pre>
<p>*1) Refer to section 5.8 “How to Enter Alphanumeric characters” To return to normal distance measurement mode, stake out distance to “0”m or turn the power off.</p>		

9.7 Offset Measurement

There are four offset measurement modes:

1. Angle offset
2. Distance offset
3. Plane offset
4. Column offset

*Offset measurement will be done by N-time fine measurement mode. For setting measuring times refer to Chapter12 “Basic Setting”.

9.7.1 Angle Offset

This mode is useful when it is difficult to set up the prism directly, for example at the center of a tree. Place the prism at the same horizontal distance from the instrument as that of point A0 to measure. To measure the coordinates of the center position, operate the offset measurement after setting the instrument height/prism height.

When measuring coordinates of ground point A1: Set the instrument height/Prism height.

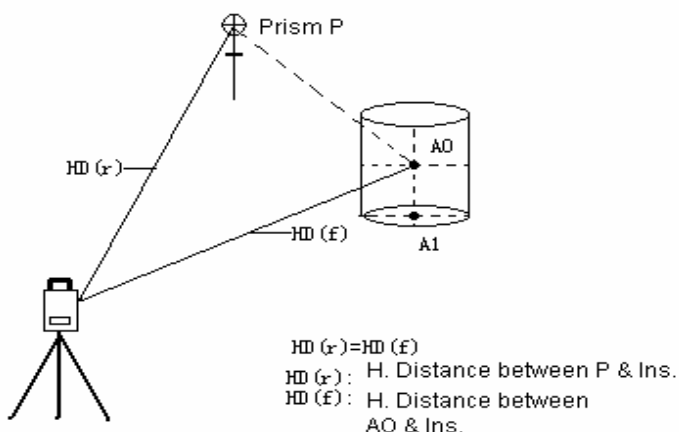

When measuring coordinates of point A0: Set the instrument height only (Set the prism height to 0).



Set the instrument height/prism height before proceeding to the offset measurement mode.

When setting the coordinate value for the occupied station, refer to Section 10.2 “Setting Coordinate Values of Occupied Point”.

Operation procedure	Operation	Display
① Press the F4 (↓) key from distance measuring mode to get the function On page 2	F4	<div style="border: 1px solid black; padding: 5px;"> HR: 170° 30' 20" HD: 566.346m VD: 89.678m MEAS MODE S/A P1 ↓ OFFSET S.O m/f/i P2 ↓ </div>
② Press F1 (OFFSET) key	F1	<div style="border: 1px solid black; padding: 5px;"> OFFSET 1/2 F1: ANG.OFFSET F2: DIST. OFFSET F3: PLANE OFFSET P1 ↓ </div>
③ Press F1 (ANG.OFFSET) key	F1	<div style="border: 1px solid black; padding: 5px;"> OFFSET-MEASUREMENT HR: 170° 30' 20" HD: m MEAS --- --- --- </div>
④ Collimate prism P, and press the F1 (MEAS) key The horizontal distance from the instrument to the prism will be measured.	Collimate [P] F1	<div style="border: 1px solid black; padding: 5px;"> OFFSET-MEASUREMENT HR: 170° 30' 20" HD* << m MEAS --- --- --- </div> <div style="border: 1px solid black; padding: 5px;"> OFFSET-MEASUREMENT HR: 170° 30' 20" HD* 547.339 m NEXT --- --- --- </div>
⑤ Press the F4 (SET) key to decide the prism position.	Collimate A0	<div style="border: 1px solid black; padding: 5px;"> OFFSET-MEASUREMENT HR: 170° 30' 20" HD: 547.339 m NEXT --- --- --- </div>
⑥ Collimate point A0 using the horizontal motion clamp and horizontal tangent screw.		<div style="border: 1px solid black; padding: 5px;"> OFFSET-MEASUREMENT HR: 170° 30' 20" VD: 2.328 m NEXT --- --- --- </div>



<p>⑦ Show the relative elevation of point A0.</p>		<div style="border: 1px solid black; padding: 5px;"> <p>OFFSET-MEASUREMENT</p> <p>HR: 170° 30' 20"</p> <p>SD: 538.888 m</p> <p>NEXT --- --- ---</p> </div>
<p>⑧ Show the slope distance of point A0</p> <p>Each time pressing the  key, horizontal distance, relative elevation and slope distance are shown in sequence.</p>		<div style="border: 1px solid black; padding: 5px;"> <p>N : 8.384 m</p> <p>E : -6.888 m</p> <p>Z : 0.146 m</p> <p>NEXT --- --- ---</p> </div>
<p>To return to procedure 4, press F1 (NEXT) key</p> <p>To return to the previous mode, press ESC key.</p>		

9.7.2 Distance Offset Measurement

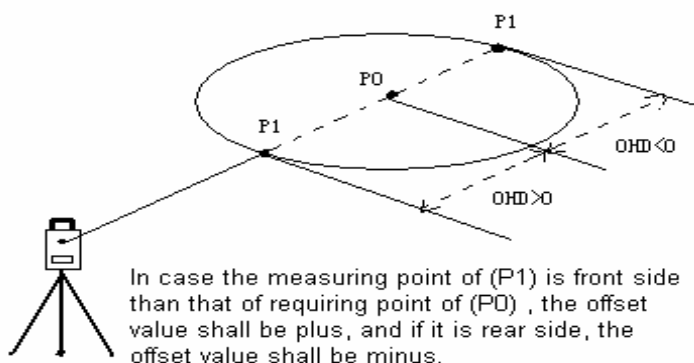
Measuring the distance and coordinate of a pond or a tree of which the radius is known. Measuring the distance or coordinate till P0 point, input oHD value as an offset value and measure P1 point showing draw in distance offset measurement. The display shows distance or coordinate value until P0 point.



When setting the coordinate value for the occupied station, refer to Section 10.2 'Setting Coordinate of Occupied Point'

Operation procedure	Operation	Display
① Press the F4 (\downarrow) key from distance measuring mode to get the function On page 2.	F4	<pre> HR: 170° 30' 20" HD: 566.346m VD: 89.678m MEAS MODE S/A P1 ↓ ----- OFSET S.O m/f/i P2 ↓ </pre>
② Press F1 (OFSET) key.	F1	<pre> OFFSET 1/2 F1: ANG.OFFSET F2: DIST. OFFSET F3: PLANE OFFSET P1 ↓ </pre>
③ Press F2 (DIST.OFFSET) key.	F2	<pre> DISTANCE OFFSET INPUT FORWARD HD OHD: 0. 000 m INPUT --- --- ENTER </pre>
④ Press F1 (INPUT) key, and enter value, and press F4 (ENTER) key.	F1 Enter offset value F4	<pre> DISTANCE OFFSET HR: 170° 30' 20" HD: m MEAS --- --- --- </pre>
⑤ Collimate Prism P1, and press F1 (MEAS) key. Measuring will start. After measuring, the result added offset value will be shown.	Collimate P1 F1	<pre> DISTANCE OFFSET HR: 170° 30' 20" HD: << m >Measuring..... </pre> <pre> DISTANCE OFFSET HR: 170° 30' 20" HD* 10.339 m NEXT --- --- --- </pre>
⑥ Show the relative elevation of Point P0 Each time pressing the  key horizontal distance, relative elevation		<pre> DISTANCE OFFSET HR: 170° 30' 20" VD: 12.328 m NEXT --- --- --- </pre>

and slope distance are shown in the sequence.		<table border="1"> <tr><td colspan="3">DISTANCE OFFSET</td></tr> <tr><td>HR:</td><td>170°</td><td>30' 20"</td></tr> <tr><td>SD:</td><td>1.218</td><td>m</td></tr> <tr><td>NEXT</td><td>---</td><td>---</td></tr> </table>	DISTANCE OFFSET			HR:	170°	30' 20"	SD:	1.218	m	NEXT	---	---
DISTANCE OFFSET														
HR:	170°	30' 20"												
SD:	1.218	m												
NEXT	---	---												
⑦ Show the coordinate of Point P0	<input type="checkbox"/>	<table border="1"> <tr><td>N :</td><td>8.384</td><td>m</td></tr> <tr><td>E :</td><td>-6.888</td><td>m</td></tr> <tr><td>Z :</td><td>0.146</td><td>m</td></tr> <tr><td>NEXT</td><td>---</td><td>---</td></tr> </table>	N :	8.384	m	E :	-6.888	m	Z :	0.146	m	NEXT	---	---
N :	8.384	m												
E :	-6.888	m												
Z :	0.146	m												
NEXT	---	---												
Press F1 (NEXT) key to return to procedure ④ To return to the previous mode, press ESC key.														

9.7.3 Plane Offset Measurement



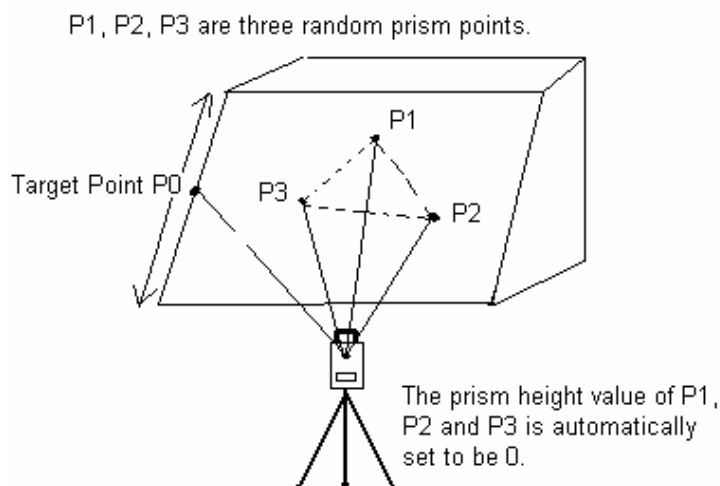

Measuring will be taken for the place where direct measuring cannot be done, for example, distance or coordinate measuring for a edge of a plane.

Three random prism points (P1, P2, P3) on a plane will be measured at first in the plane offset measurement to determine the measured plane. Collimate the measuring target point (P0) then the instrument calculates and displays coordinate and distance value of cross point between collimation axis and of the plane.



When setting the coordinate value for the occupied station, refer to Section 10.2 ‘Setting Coordinate Values of Occupied Point’.

Operation procedure	Operation	Display
① Press the F4 (↓) key from distance measuring mode to get the function On page 2.	F4	<div style="border: 1px solid black; padding: 5px;"> HR: 170° 30' 20" HD: 566.346m VD: 89.678m MEAS MODE S/A P1 ↓ OFFSET S.O m/f/i P2 ↓ </div>
② Press F1 (OFFSET) key.	F1	<div style="border: 1px solid black; padding: 5px;"> OFFSET 1/2 F1: ANG.OFFSET F2: DIST. OFFSET F3: PLANE OFFSET P1 ↓ </div>
③ Press F3 (PLANE OFFSET) key	F3	<div style="border: 1px solid black; padding: 5px;"> PLANE N001# SD*: m MEAS --- --- --- </div>
④ Collimate Prism P1 , Press F1 (MEAS) key. N-times measuring will start. After measuring, the display will show the second point measurement.	Collimate P1 F1	<div style="border: 1px solid black; padding: 5px;"> PLANE N001# SD*[n]: <<m Measuring..... </div>
⑤ Measure the second and third points in the same way. The instrument calculates and displays coordinate and distance value of cross point between collimation axis and of the plane .*(1)、2)	Collimate P2 F1 Collimate P3 F1	<div style="border: 1px solid black; padding: 5px;"> PLANE N002# SD*: m MEAS --- --- --- </div> <div style="border: 1px solid black; padding: 5px; margin-top: 10px;"> PLANE N003# SD*: m MEAS --- --- --- </div>

		<div style="border: 1px solid black; padding: 5px;"> HR: 170° 30' 20" HD: 12.328 m VD*: 1.314 m NEXT --- --- --- </div>
⑥Collimate the edge (P0) of the plane *3) 4)	Collimate P0	<div style="border: 1px solid black; padding: 5px;"> HR: 50° 10' 12" HD: 11.314 m VD*: 4.245 m NEXT --- --- --- </div>
⑦To show the slope(SD), Press  , Each time pressing  key, horizontal distance, relative elevation and slope distance are shown in sequence. To show the coordinate of point (P0), press  key.		<div style="border: 1px solid black; padding: 5px;"> V: 80° 45' 45" HR: 50° 10' 12" SD*: 4.245 m NEXT --- --- --- </div>
<p>*1) In case the calculation of plane was not successful by the measured three points, error displays. Start measuring over again from the first point.</p> <p>*2) Data display is the mode beforehand of offset measurement mode.</p> <p>*3) Error will be displayed when collimated to the direction which does not cross with determined plane.</p> <p>*4) The reflector height of the target point P0 is set to zero automatically.</p>		

9.7.4 Column Offset Measurement



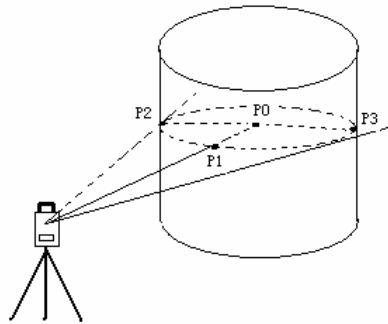

If it is possible to measure circumscription point (P1) of Column directly the distance to the center of the column (P0), coordinate and direction angle can be calculated by measured circumscription points (P2) and (P3).

The direction angle of the center of the column is 1/2 of total direction angle of circumscription points (P2) and (P3).



When setting the coordinate value for the occupied station, refer to Section 7.2 ‘Setting Coordinate Values of Occupied Point’.

Operation procedure	Operation	Display										
① Press the F4 (↓) key from distance measuring mode to get the function on page 2.	F4	<table border="1"> <tr> <td>HR:</td> <td>170° 30' 20"</td> </tr> <tr> <td>HD:</td> <td>566.346m</td> </tr> <tr> <td>VD:</td> <td>89.678m</td> </tr> <tr> <td>MEAS MODE</td> <td>S/A P1 ↓</td> </tr> <tr> <td>OFFSET</td> <td>S.O m/f/i P2 ↓</td> </tr> </table>	HR:	170° 30' 20"	HD:	566.346m	VD:	89.678m	MEAS MODE	S/A P1 ↓	OFFSET	S.O m/f/i P2 ↓
HR:	170° 30' 20"											
HD:	566.346m											
VD:	89.678m											
MEAS MODE	S/A P1 ↓											
OFFSET	S.O m/f/i P2 ↓											
② Press F1 (OFFSET) key.	F1	<table border="1"> <tr> <td>OFFSET</td> <td>1/2</td> </tr> <tr> <td>F1:</td> <td>ANG.OFFSET</td> </tr> <tr> <td>F2:</td> <td>DIST. OFFSET</td> </tr> <tr> <td>F3:</td> <td>PLANE OFFSET P1 ↓</td> </tr> </table>	OFFSET	1/2	F1:	ANG.OFFSET	F2:	DIST. OFFSET	F3:	PLANE OFFSET P1 ↓		
OFFSET	1/2											
F1:	ANG.OFFSET											
F2:	DIST. OFFSET											
F3:	PLANE OFFSET P1 ↓											
③ Press F4 (P1 ↓) key	F4	<table border="1"> <tr> <td>OFFSET</td> <td>2/2</td> </tr> <tr> <td>F1:</td> <td>COLUMN OFFSET</td> </tr> <tr> <td></td> <td>P1 ↓</td> </tr> </table>	OFFSET	2/2	F1:	COLUMN OFFSET		P1 ↓				
OFFSET	2/2											
F1:	COLUMN OFFSET											
	P1 ↓											
④ Press F1 (COLUMN OFFSET) key	F1	<table border="1"> <tr> <td>COLUMN OFFSET</td> <td></td> </tr> <tr> <td>Center</td> <td></td> </tr> <tr> <td>HD :</td> <td>m</td> </tr> <tr> <td>MEAS</td> <td>--- --- ---</td> </tr> </table>	COLUMN OFFSET		Center		HD :	m	MEAS	--- --- ---		
COLUMN OFFSET												
Center												
HD :	m											
MEAS	--- --- ---											

<p>⑤ Collimate the center of the column (P1) and press F1 (MEAS) key N-time measuring will start. After the measurement, angle measuring display of the left side (P2) will be shown.</p>	<p>Collimate P1 F1</p>	<div style="border: 1px solid black; padding: 5px;"> <p>COLUMN OFFSET Center HD*[n]: m >Measuring.....</p> </div>
<p>⑥ Collimate the left side of column(P2) and press F4 (SET) key. After measurement, angle measuring display of the right side (P3) will be shown.</p>	<p>Collimate P2 F4</p>	<div style="border: 1px solid black; padding: 5px;"> <p>COLUMN OFFSET Left HR: 170° 30' 20" --- --- --- SET</p> </div>
<p>⑦ Collimate the right side of the column (P3) and press F4 (SET) key. After measurement, the distance between the instrument and the center of column (P0) will be calculated.</p>	<p>Collimate P3 F4</p>	<div style="border: 1px solid black; padding: 5px;"> <p>COLUMN OFFSET Right HR: 230° 30' 20" --- --- --- SET</p> </div> <div style="border: 1px solid black; padding: 5px; margin-top: 5px;"> <p>COLUMN OFFSET HR: 120° 30' 20" HD : 24.251 m NEXT --- --- ---</p> </div>
<p>⑧ To show the relative elevation (VD), press  key. Each time pressing the  key, horizontal distance, relative elevation and slope distance are shown in sequence. To show the coordinate of point P0, press  key.</p>	<p></p>	<div style="border: 1px solid black; padding: 5px;"> <p>COLUMN OFFSET HR: 100° 30' 20" VD : 2.185 m NEXT --- --- ---</p> </div>
<p>⑨ To escape the measuring, press ESC key. The display returns to the previous mode.</p>		

10. COORDINATE MEASUREMENT

10.1 Execution of Coordinate Measurement

Measure the coordinates by entering the instrument height and prism height, coordinates of unknown Point will be measured directly.

○When setting coordinate values of occupied point, see Section 10.2“Setting Coordinate Values of Occupied Point”.

○When setting the instrument height and prism height, see Section 10.3 “Setting Height of the Instrument” and 10.4 “Setting Height of Target (prism Height)”.

○To set backsight, decide the backsight azimuth, and check the known azimuth, coordinate and distance.

The coordinates of the unknown point are calculated as shown below and displayed:

Coordinates of occupied point (N0, E0, Z0)

Instrument height :INS.HT

Prism height: R.HT

Vertical distance (Relative elevation): Z (VD)

Coordinates of the center of the prism, originated from the center point of the instrument (n,e,z)

Coordinates of unknown point: (N1, E1, Z1)

$$N1=N0+n$$



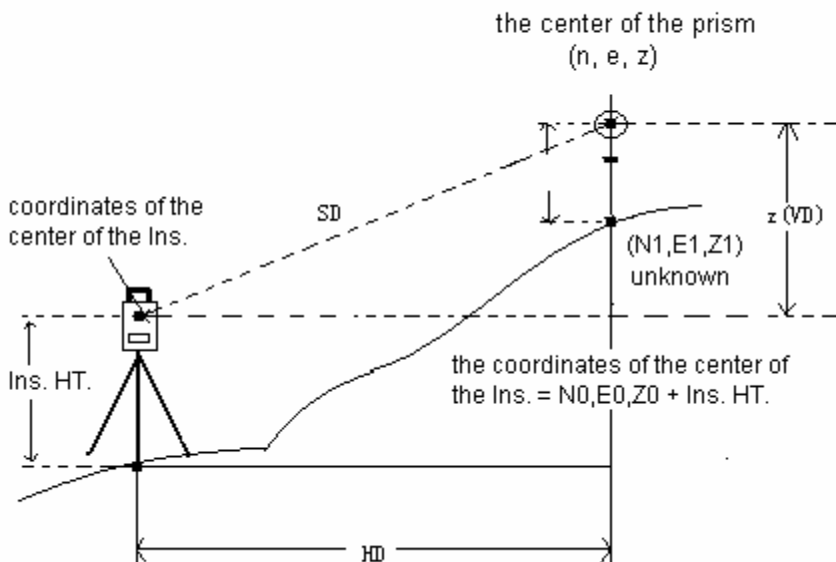

$$E1=E0+e$$

$$Z1=Z0+INS.HT+Z-R.HT$$

Center point of the instrument (N0, E0, Z0+INS.HT)



When doing coordinate measurement, coordinates of occupied point, instrument height, prism height and back sight azimuth should be set.

Operation procedure	Operation	Display
① Set the direction angle of known point A *1)	Set direction angle	V: 122° 09' 30" HR: 90° 09' 30" 0SET HOLD HSET P1 ↓
② Collimate target prism B, and press  key.	Collimate target prism 	N: << m E: m Z: m MEAS MODE S/A P1 ↓
③ Press the  key, measuring starts		N* 286.245 m E: 76.233 m Z: 14.568 m MEAS MODE S/A P1 ↓

*1) Refer to Section 8.3 “Setting of Horizontal Angle”.

In case the coordinate of instrument point is not entered, (0,0,0) will be used as the default for the instrument point.

The instrument height will be calculated as 0 when the instrument height is not entered.

The prism height will be calculated as 0 when the prism height is not set.

10.2 Setting Coordinate Values of Occupied Point

Set the coordinates of the instrument (occupied point) according to coordinates origin, and the instrument automatically converts and displays the unknown point (prism point) coordinates following the origin.

It is possible to retain the coordinates of the occupied point after turning the power off. Refer to Chapter 15 “Basic Setting”.

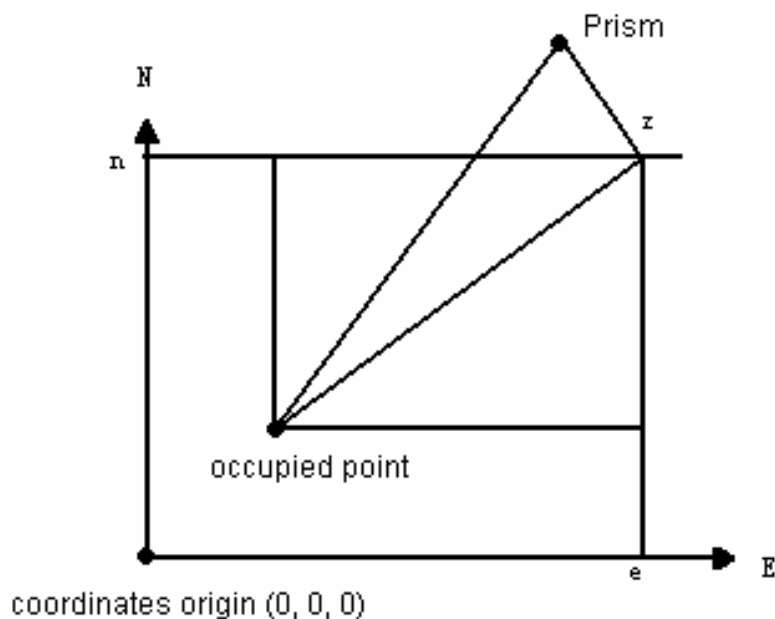

Operation procedure	Operation	Display															
① Press the F4 (↓) key from the coordinate measurement mode to get the function on page 2.	F4	<table border="1"> <tr><td>N:</td><td>286.245</td><td>m</td></tr> <tr><td>E:</td><td>76.233</td><td>m</td></tr> <tr><td>Z:</td><td>14.568</td><td>m</td></tr> <tr><td>MEAS</td><td>MODE</td><td>S/A P1 ↓</td></tr> <tr><td>R.HT</td><td>INSHT</td><td>OCC P2 ↓</td></tr> </table>	N:	286.245	m	E:	76.233	m	Z:	14.568	m	MEAS	MODE	S/A P1 ↓	R.HT	INSHT	OCC P2 ↓
N:	286.245	m															
E:	76.233	m															
Z:	14.568	m															
MEAS	MODE	S/A P1 ↓															
R.HT	INSHT	OCC P2 ↓															
② Press the F3 (OCC) key	F3	<table border="1"> <tr><td>N-></td><td>0.000</td><td>m</td></tr> <tr><td>E:</td><td>0.000</td><td>m</td></tr> <tr><td>Z:</td><td>0.000</td><td>m</td></tr> <tr><td>INPUT</td><td>---</td><td>---- ENTER</td></tr> </table>	N->	0.000	m	E:	0.000	m	Z:	0.000	m	INPUT	---	---- ENTER			
N->	0.000	m															
E:	0.000	m															
Z:	0.000	m															
INPUT	---	---- ENTER															
③ Enter N coordinate value *1)	F1 Enter data F4	<table border="1"> <tr><td>N:</td><td>36.976</td><td>m</td></tr> <tr><td>E-></td><td>0.000</td><td>m</td></tr> <tr><td>Z:</td><td>0.000</td><td>m</td></tr> <tr><td>INPUT</td><td>---</td><td>---- ENTER</td></tr> </table>	N:	36.976	m	E->	0.000	m	Z:	0.000	m	INPUT	---	---- ENTER			
N:	36.976	m															
E->	0.000	m															
Z:	0.000	m															
INPUT	---	---- ENTER															
④ Enter E and Z coordinate values in the same manner. After entering the values, the display returns coordinate measuring display.		<table border="1"> <tr><td>N:</td><td>36.976</td><td>m</td></tr> <tr><td>E:</td><td>298.578</td><td>m</td></tr> <tr><td>Z:</td><td>45.330</td><td>m</td></tr> <tr><td>MEAS</td><td>MODE</td><td>S/A P1 ↓</td></tr> </table>	N:	36.976	m	E:	298.578	m	Z:	45.330	m	MEAS	MODE	S/A P1 ↓			
N:	36.976	m															
E:	298.578	m															
Z:	45.330	m															
MEAS	MODE	S/A P1 ↓															
<p>*1) Refer to Section 5.8 “How to Enter Alphanumeric characters”.</p> <p>Input range:</p> <p>-999999.999 ↖ N、E、Z ↗ +999999.999m</p> <p>-999999.999 ↖ N、E、Z ↗ +999999.999ft</p> <p>-999999.11.7 ↖ N、E、Z ↗ +999999.11.7ft+inch</p>																	

10.3 Setting Height of the Instrument

It is possible to retain the height of instrument after running the power off. Refer to Chapter 15 “Basic Setting”.

Operation procedure	Operation	Display																
① Press the F4 (↓) key from the coordinate measurement mode to get the function on page 2.	F4	<table border="1"> <tr><td>N:</td><td>286.245</td><td>m</td></tr> <tr><td>E:</td><td>76.233</td><td>m</td></tr> <tr><td>Z:</td><td>14.568</td><td>m</td></tr> <tr><td>MEAS</td><td>MODE</td><td>S/A P1 ↓</td></tr> <tr><td>R.HT</td><td>INSHT</td><td>OCC P2 ↓</td></tr> </table>	N:	286.245	m	E:	76.233	m	Z:	14.568	m	MEAS	MODE	S/A P1 ↓	R.HT	INSHT	OCC P2 ↓	
N:	286.245	m																
E:	76.233	m																
Z:	14.568	m																
MEAS	MODE	S/A P1 ↓																
R.HT	INSHT	OCC P2 ↓																
② Press the F2 (INS.HT) key. The current value is displayed.	F2	<table border="1"> <tr><td colspan="4">INSTRUMENT HEIGHT</td></tr> <tr><td colspan="4">INPUT</td></tr> <tr><td>INS.HT</td><td>0.000</td><td>m</td><td></td></tr> <tr><td>INPUT</td><td>---</td><td>---</td><td>ENTER</td></tr> </table>	INSTRUMENT HEIGHT				INPUT				INS.HT	0.000	m		INPUT	---	---	ENTER
INSTRUMENT HEIGHT																		
INPUT																		
INS.HT	0.000	m																
INPUT	---	---	ENTER															
③ Enter the instrument height *1)	F1 enter F4	<table border="1"> <tr><td>N:</td><td>286.245</td><td>m</td></tr> <tr><td>E:</td><td>76.233</td><td>m</td></tr> <tr><td>Z:</td><td>14.568</td><td>m</td></tr> <tr><td>MEAS</td><td>MODE</td><td>S/A P1 ↓</td></tr> </table>	N:	286.245	m	E:	76.233	m	Z:	14.568	m	MEAS	MODE	S/A P1 ↓				
N:	286.245	m																
E:	76.233	m																
Z:	14.568	m																
MEAS	MODE	S/A P1 ↓																
*1) Refer to Section 5.8 “How to Enter Alphanumeric characters” Input range: —999.999≤INS.HT≤+999.999m —999.999≤INS.HT≤+999.999ft —999.11.7≤INS.HT≤+999.11.7ft+inch																		

10.4 Setting Height of Target (Prism Height)

This mode can be used to obtain z coordinate values. It is possible to retain the height of target after turning the power off. Refer to Chapter 15 “Basic Setting”.

Operation procedure	Operation	Display
---------------------	-----------	---------

<p>① Press the F4 (↓) key from the coordinate measurement mode to get the function on page 2.</p>	<p>F4</p>	<table border="1"> <tr> <td>N:</td> <td>286.245</td> <td>m</td> </tr> <tr> <td>E:</td> <td>76.233</td> <td>m</td> </tr> <tr> <td>Z:</td> <td>14.568</td> <td>m</td> </tr> <tr> <td>MEAS</td> <td>MODE</td> <td>S/A P1 ↓</td> </tr> <tr> <td>R.HT</td> <td>INSHT</td> <td>OCC P2 ↓</td> </tr> </table>	N:	286.245	m	E:	76.233	m	Z:	14.568	m	MEAS	MODE	S/A P1 ↓	R.HT	INSHT	OCC P2 ↓
N:	286.245	m															
E:	76.233	m															
Z:	14.568	m															
MEAS	MODE	S/A P1 ↓															
R.HT	INSHT	OCC P2 ↓															
<p>② Press the F1 (R.HT) key The current value is displayed.</p>	<p>F1</p>	<table border="1"> <tr> <td colspan="2">REFLECTOR HEIGHT</td> </tr> <tr> <td colspan="2">INPUT</td> </tr> <tr> <td>R.HT</td> <td>0.000 m</td> </tr> <tr> <td>INPUT</td> <td>--- --- ENTER</td> </tr> </table>	REFLECTOR HEIGHT		INPUT		R.HT	0.000 m	INPUT	--- --- ENTER							
REFLECTOR HEIGHT																	
INPUT																	
R.HT	0.000 m																
INPUT	--- --- ENTER																
<p>③ Enter the prism height *1)</p>	<p>F1 Enter F4</p>	<table border="1"> <tr> <td>N:</td> <td>286.245</td> <td>m</td> </tr> <tr> <td>E:</td> <td>76.233</td> <td>m</td> </tr> <tr> <td>Z:</td> <td>14.568</td> <td>m</td> </tr> <tr> <td>MEAS</td> <td>MODE</td> <td>S/A P1 ↓</td> </tr> </table>	N:	286.245	m	E:	76.233	m	Z:	14.568	m	MEAS	MODE	S/A P1 ↓			
N:	286.245	m															
E:	76.233	m															
Z:	14.568	m															
MEAS	MODE	S/A P1 ↓															
<p>*1) Refer to Section 5.8 “How to Enter Alphanumeric characters”</p> <p>Input range:</p> <p style="text-align: center;">—999.999 ≤ prism height ≤ +999.999m</p> <p style="text-align: center;">—999.999 ≤ prism height ≤ +999.999f</p> <p style="text-align: center;">—999.11.7 ≤ prism height ≤ +999.11.7f+inch</p>																	

11. SPECIAL MODE

11.1 Surveying Program Mode (PROGRAMS)

By pressing the **MENU** key, the instrument will be in Menu Mode. In this mode, special measuring, setting and adjustment are possible.

11.1.1 Remote Elevation Measurement (REM)

To obtain elevation of the point at which setting the target prism is not possible, place the prism at any point on the vertical line from the target then carry out REM procedure as follows.

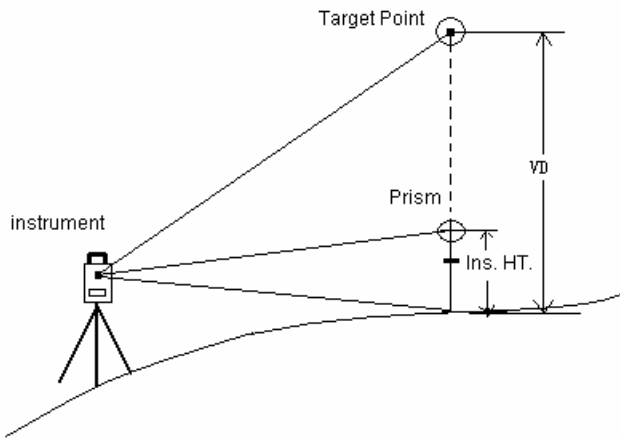

1) With prism height(h)input (Example: h=1.3m)

Operation procedure	Operation	Display								
① After pressing the MENU key, press the F4 (P ↓) key to get the menu on page 2.	MENU F4	<table border="1"> <tr> <td>MENU</td> <td>2 / 3</td> </tr> <tr> <td>F1: PROGRAMS</td> <td></td> </tr> <tr> <td>F2: GRID FACTOR</td> <td></td> </tr> <tr> <td>F3: ILLUMINATION</td> <td>P1 ↓</td> </tr> </table>	MENU	2 / 3	F1: PROGRAMS		F2: GRID FACTOR		F3: ILLUMINATION	P1 ↓
MENU	2 / 3									
F1: PROGRAMS										
F2: GRID FACTOR										
F3: ILLUMINATION	P1 ↓									

<p>② Press the F1 key, enter PROGRAMS.</p>	<p>F1</p>	<pre>PROGRAMS 1/2 F1: REM F2: MLM F3: Z COORD.</pre>
<p>③ Press the F1 (REM) key</p>	<p>F1</p>	<pre>REM F1: INPUT R.HT F2: NO R.HT</pre>
<p>④ Press the F1 key</p>	<p>F1</p>	<pre>REM-1 <STEP-1> R.HT : 0.000m INPUT --- --- ENTER</pre>
<p>⑤ Enter prism height *1)</p>	<p>F1 Enter 1.3 F4</p>	<pre>REM-1 <STEP-2> HD : m MEAS --- --- SET</pre>
<p>⑥ Collimate prism</p>	<p>Collimate P</p>	<pre>REM-1 <STEP-2> HD* << m MEAS --- --- SET</pre>
<p>⑦ Press the F1 (MEAS) key, measurement starts. Horizontal distance (HD) between the instrument and prism will be shown.</p>	<p>F1</p>	<pre>REM-1 <STEP-2> HD* 123.342 m MEAS --- --- SET</pre>
<p>⑧ Press the F4 (SET) The prism position will be decided *2)</p>	<p>F4</p>	<pre>REM-1 VD : 3.435 m --- R.HT HD ---</pre>
<p>⑨ Collimate target K. Vertical distance (VD) will be shown. *3)</p>	<p>Collimate K</p>	<pre>REM-1 VD : 24.287 m --- R.HT HD ---</pre>

*1) Refer to Section 5.8 “How to Enter Alphanumeric characters”.

*2) To return to procedure ⑤, press the **F2** (R,HT)key.

To return to procedure ⑥, press the **F3** (HD)key.

*3) To return to PROGRAMS Menu, press the **ESC** key.

2) Without prism height input

Operation procedure	Operation	Display
①After pressing the MENU key, press the F4 (P ↓) key to get the menu on page 2.	MENU F4	MENU 2 / 3 F1: PROGRAMS F2: GRID FACTOR F3: ILLUMINATION P1 ↓
② Press the F1 key to enter Special Program Mode.	F1	PROGRAMS 1/2 F1: REM F2: MLM F3: Z COORD.
③Press the F1 (REM) Key.	F1	REM F1: INPUT R.HT F2: NO R.HT
④Press the F2 key to select the mode without prism height.	F2	REM-2 <STEP-1> HD : m MEAS --- --- SET
⑤Collimate prism	Collimate P F1	REM-2 <STEP-1> HD* << m MEAS --- --- SET
⑥Press the F1 (MEAS) key. Measuring starts. Horizontal distance (HD) between the instrument and prism will be shown.	F1	REM-2 <STEP-1> HD* 287.567 m MEAS --- --- SET

<p>⑦ Press the F4 (SET)</p> <p>The prism position will be decided.</p>	<p>F4</p>	<pre> REM-2 <STEP-2> V: 80° 09' 30" --- --- --- SET </pre>
<p>⑧ Collimate ground point G</p>	<p>Collimate G</p>	<pre> REM-2 <STEP-2> V: 122° 09' 30" --- --- --- SET </pre>
<p>⑨ Press the F4 (SET) key. The position of point G will be decided. *1)</p>	<p>F4</p>	<pre> REM-2 VD: 0.000 m --- V HD --- </pre>
<p>⑩ Collimate target K</p> <p>Vertical distance (VD) will be shown. *2)</p>	<p>Collimate K</p>	<pre> REM-2 V D: 10.224 m --- V HD --- </pre>
<p>*1) To return to procedure 5, press the F3 (HD) key. To return to procedure 8, press the F2 (V) key.</p> <p>*2) To return to PROGRAMS Menu, press the ESC key.</p>		

11.1.2 Missing Line Measurement (MLM)

Measurement for horizontal distance (dHD), slope distance (dVD), elevation (dVR) and horizontal bearing (HR) between two target prisms.

It is possible to enter the coordinate value directly or calculate from coordinate data file.

MLM Mode has two modes:

1. MLM-1 (A-B, A-C): Measurement A-B, A-C, A-D
2. MLM-2 (A-B, B-C): Measurement A-B, B-C, C-D.....

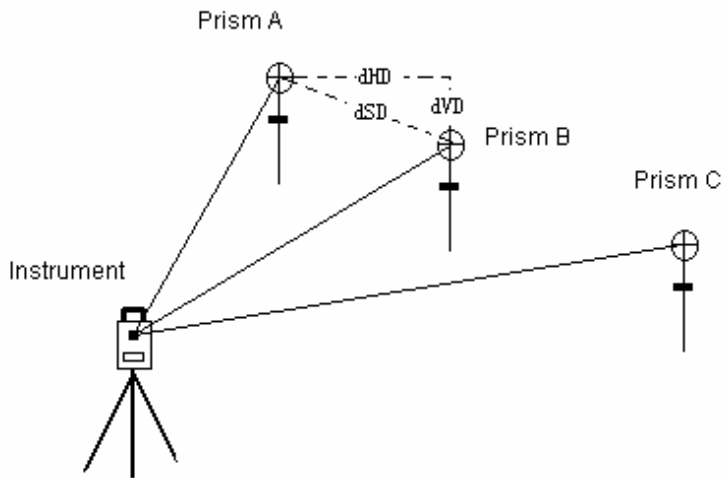

It is necessary to set the direction angle of the instrument.

[Example] MLM-1 (A-B, A-C)

Procedure of MLM-2 (A-B, B-C) mode is completely the same as that of MLM-1 mode.

Operation procedure	Operation	Display
① After pressing the MENU key, press the F4 (P ↓) key to get the menu on page 2.	MENU F4	MENU 2 / 3 F1: PROGRAMS F2: GRID FACTOR F3: ILLUMINATION P1 ↓
② Press the F1 key, enter PROGRAMS.	F1	PROGRAMS 1 / 2 F1: REM F2: MLM F3: Z COORD. P1 ↓
③ Press the F2 (MLM) key	F2	MLM F1: USE FILE F2: DON'T USE

<p>④ Press the F1 or F2 key to select using coordinate file [Example: F2: DON' T USE]</p>	<p>F2</p>	<p>MLM F1: USE G. F. F2: DON'T USE</p>
<p>⑤ Press the F1 or F2 key to select using GRID FACTOR</p>	<p>F2</p>	<p>MLM F1: MLM-1 (A-B, A-C) F2: MLM-2 (A-B, B-C)</p>
<p>⑥ Press the F1 key</p>	<p>F1</p>	<p>MLM -1(A-B, A-C) <SETP-1> HD: m MEAS R.HT NEZ SET</p>
<p>⑦ Collimate prism A, and press the F1 (MEAS) key. Horizontal distance (HD) between the instrument and prism A will be shown.</p>	<p>Collimate A F1</p>	<p>MLM-1 (A-B, A-C) <SETP-1> HD* << m MEAS R.HT NEZ SET</p> <hr/> <p>MLM-1 (A-B, A-C) <SETP-1> HD* 287.882 m MEAS R.HT NEZ SET</p>
<p>⑧ Press the F4 (SET) key</p>	<p>F4</p>	<p>MLM-1 (A-B, A-C) <SETP-2> HD: m MEAS R.HT NEZ SET</p>

<p>①After pressing MENU key, press F4 (p ↓)key to get the menu on page2.</p>	<p>MENU</p> <p>F4</p>	<pre> MENU 2 / 3 F1: PROGRAMS F2: GRID FACTOR F3: ILLUMINATION P1 ↓ </pre>
<p>②Press the F1 key ,enter PROGRAMS</p>	<p>F1</p>	<pre> PROGRAMS 1 / 2 F1: REM F2: MLM F3: Z COORD. P1 ↓ </pre>
<p>③Press the F3 \ (z coord) key</p>	<p>F3</p>	<pre> Z COORD.SETTING F1: USE FILE F2: DON'T USE </pre>
<p>④Press the F1 (USE FILE) key</p>	<p>F1</p>	<pre> SELECT A FILE FN: _____ INPUT LIST --- ENTER </pre>
<p>⑤Press the F1 (INPUT) key and enter the File Name.</p>	<p>F1 Enter FN F4</p>	<pre> Z COORD.SETTING F1: OCC.PT INPUT F2: REF.MEAS </pre>
<p>⑥Press the F1 key</p>	<p>F1</p>	<pre> OCC.PT PT#: _____ INPUT LIST NEZ ENTER </pre>
<p>⑦Press the F1 (INPUT) key and enter the Point number in coordinate data file. Instrument height setting display will be shown.</p>	<p>F1 Enter PT # F4</p>	<pre> INSTRUMENT HEIGHT INPUT INS.HT: 0.000 m INPUT --- --- ENTER </pre>
<p>⑧Press the F4 (INPUT) key and enter the instrument height. The display returns to Z coordinate menu.</p>	<p>F1 Enter INS.HT F4</p>	<pre> Z COORD.SETTING F1: OCC.PT INPUT F2: REF.MEAS </pre>
<p>For more information about data file, see chapter 14 “Memory Management Mode”.</p>		

2) Z coordinate calculation from known point measuring data

[Example setting] Using coordinate data file.

Operation procedure	Operation	Display
① After pressing MENU key, press F4 (p ↓) key to get the menu on page2.	MENU F4	MENU 2 / 3 F1: PROGRAMS F2: GRID FACTOR F3: ILLUMINATION P1 ↓
② Press the F1 key	F1	PROGRAMS 1 / 2 F1: REM F2: MLM F3: Z COORD. P1 ↓
③ Press the F3 (z coord) key	F3	Z COORD.SETTING F1: USE FILE F2: DON'T USE
④ Press the F1 (USE FILE) key	F1	SELECT A FILE FN: _____ INPUT LIST --- ENTER
⑤ Press the F1 (INPUT) key and enter the File Name	F1 Enter FN F4	Z COORD.SETTING F1: OCC.PT INPUT F2: REF.MEAS
⑥ Press the F2 key	F2	N001# PT#: _____ INPUT LIST --- ENTER
⑦ Press the F1 (INPUT) key and enter the Point number in coordinate data file.	F1 Enter PT# F4	N: 4.237 m E: 23.836 m Z: 1.356 m >OK? [YES] [NO]

<p>⑧ Press the F3 (YES) key and enter the Point Number in coordinate data file.</p>	<p>F3</p>	<pre>REFLECTOR HEIGHT INPUT R.HT 0.000 m INPUT --- --- ENTER</pre>
<p>⑨ Press the F1 (INPUT) key and enter the height.</p>	<p>F1 Enter R.HT F4</p>	<pre>REFLECTOR HEIGHT INPUT R.HT 1.000 m >Sight? [YES] [NO]</pre>
<p>⑩ Collimate a prism on the point and press the F3 (YES) key. Measuring starts *1)</p>	<p>Collimate P F3</p>	<pre>HR: 90° 09' 30" HD* << m VD: m >Measuring... HR: 90° 09' 30" HD: 12.534 m VD: 23.769 m NEXT --- --- CALC</pre>
<p>11. Press the F4 (CALC) key *2) Z: Z coordinate dZ: Standard deviation</p>	<p>F4</p>	<pre>Z COORD.SETTING Z : 12.534 m dZ: 0.365 m --- --- BS SET</pre>
<p>12. Press the F4 (SET) key *3) Z coordinate of the occupied point will be set. Backsight point measuring screen will be shown.</p>	<p>F4</p>	<pre>BACKSIGHT HR: 90° 09' 30" >OK? [YES] [NO]</pre>
<p>13. Press the F3 (YES) key Horizontal angle will be set The display returns to Programs 1/2 menu</p>	<p>F3</p>	<pre>Z COORD.SETTING F1: OCC.PT INPUT F2: REF.MEAS</pre>
<p>*1) Measurement is Fine Single measurement mode. *2) To measure other points, press the F1 (NEXT) key. *3) Pressing the F3 key, the display will be changed alternately</p>		

11.1.4 Area Calculation

This mode calculates the area of a closed figure.

There are two area calculation methods as follows:

- 1) Area calculation from Coordinate data file
- 2) Area calculation from Measured data

Note:

Area is not calculated correctly if enclosed lines cross each other.

It is impossible to calculate what a mix of coordinate file data and measured data.

The number of points used to calculate are not limited.

The area to be calculated shall not exceed 200000 sq.m or 2000000 square feet.

1) Area calculation from Coordinate data file

Operation procedure	Operation	Display
①After pressing MENU key, press F4 (p ↓)key to get the menu on page2.	MENU F4	MENU 2 / 3 F1: PROGRAMS F2: GRID FACTOR F3: ILLUMINATION P1 ↓
②Press the F1 key	F1	PROGRAMS 1 / 2 F1: REM F2: MLM F3: Z COORD. P1 ↓
③Press F4 (P1 ↓) key	F4	PROGRAMS 2 / 2 F1: AREA F2: POINT TO LINE P1 ↓
④Press F1 (AREA) key	F1	AREA F1: FILE DATA F2: MEASUREMENT
⑤Press F1 (FILE DATA) key	F1	SELECT A FILE FN: _____ INPUT LIST --- ENTER

⑥Press F1 (INPUT) key and enter file name. Press F4 . Initial display will be shown.	F1 Enter FN F4	<table border="1"> <tr><td>AREA</td><td>0000</td></tr> <tr><td></td><td>m.sq</td></tr> <tr><td>NEXT #:</td><td>DATA-01</td></tr> <tr><td>PT#</td><td>LIST</td><td>UNIT</td><td>NEXT</td></tr> </table>	AREA	0000		m.sq	NEXT #:	DATA-01	PT#	LIST	UNIT	NEXT
AREA	0000											
	m.sq											
NEXT #:	DATA-01											
PT#	LIST	UNIT	NEXT									
⑦Press F4 (NEXT) key *1) *2) The top of the file data (DATA-01) will be set and the second point number will be shown.	F4	<table border="1"> <tr><td>AREA</td><td>0000</td></tr> <tr><td></td><td>m.sq</td></tr> <tr><td>NEXT#:</td><td>DATA-02</td></tr> <tr><td>PT#</td><td>LIST</td><td>UNIT</td><td>NEXT</td></tr> </table>	AREA	0000		m.sq	NEXT#:	DATA-02	PT#	LIST	UNIT	NEXT
AREA	0000											
	m.sq											
NEXT#:	DATA-02											
PT#	LIST	UNIT	NEXT									
⑧Repeat pressing F4 (NEXT) key to set required number of the points. When 3 points are set, the area surrounded by the points is calculated and the result will be shown.	F4	<table border="1"> <tr><td>AREA</td><td>0000</td></tr> <tr><td></td><td>156. 144m.sq</td></tr> <tr><td>NEXT #:</td><td>DATA-12</td></tr> <tr><td>PT#</td><td>LIST</td><td>UNIT</td><td>NEXT</td></tr> </table>	AREA	0000		156. 144m.sq	NEXT #:	DATA-12	PT#	LIST	UNIT	NEXT
AREA	0000											
	156. 144m.sq											
NEXT #:	DATA-12											
PT#	LIST	UNIT	NEXT									
<p>*1) To set required point number, press F1 (PT#) key.</p> <p>*2) To show the list of the coordinate data in the file, press F2 (LIST) key.</p>												

2) Area calculation from Measured data

Operation procedure	Operation	Display									
①After pressing MENU key, press F4 (p ↓) key to get the menu on page2.	MENU F4	<table border="1"> <tr><td>MENU</td><td>2 / 3</td></tr> <tr><td>F1:</td><td>PROGRAMS</td></tr> <tr><td>F2:</td><td>GRID FACTOR</td></tr> <tr><td>F3:</td><td>ILLUMINATION</td><td>P1 ↓</td></tr> </table>	MENU	2 / 3	F1:	PROGRAMS	F2:	GRID FACTOR	F3:	ILLUMINATION	P1 ↓
MENU	2 / 3										
F1:	PROGRAMS										
F2:	GRID FACTOR										
F3:	ILLUMINATION	P1 ↓									
②Press the F1 key	F1	<table border="1"> <tr><td>PROGRAMS</td><td>1 / 2</td></tr> <tr><td>F1:</td><td>REM</td></tr> <tr><td>F2:</td><td>MLM</td></tr> <tr><td>F3:</td><td>Z COORD.</td><td>P1 ↓</td></tr> </table>	PROGRAMS	1 / 2	F1:	REM	F2:	MLM	F3:	Z COORD.	P1 ↓
PROGRAMS	1 / 2										
F1:	REM										
F2:	MLM										
F3:	Z COORD.	P1 ↓									
③Press F4 (P1 ↓) key.	F4	<table border="1"> <tr><td>PROGRAMS</td><td>2 / 2</td></tr> <tr><td>F1:</td><td>AREA</td></tr> <tr><td>F2:</td><td>POINT TO LINE</td></tr> <tr><td></td><td></td><td>P1 ↓</td></tr> </table>	PROGRAMS	2 / 2	F1:	AREA	F2:	POINT TO LINE			P1 ↓
PROGRAMS	2 / 2										
F1:	AREA										
F2:	POINT TO LINE										
		P1 ↓									

④ Press F1 (AREA) key.	F1	<div style="border: 1px solid black; padding: 5px;"> AREA F1: FILE DATA F2: MEASUREMENT </div>
⑤ Press F2 (MEASUREMENT) key	F2	<div style="border: 1px solid black; padding: 5px;"> AREA F1: USE G. F. F2: DON'T USE </div>
⑥ Press F1 or F2 key to select using GRID FACTOR or not. Example: F2 DON' T USE	F2	<div style="border: 1px solid black; padding: 5px;"> AREA 0000 m.sq MEAS --- UNIT --- </div>
⑦ Collimate a prism and press the F1 (MEAS) key. Measuring stars*1)	Collimate P F1	<div style="border: 1px solid black; padding: 5px;"> N*[n] << m E : m Z : m >Measuring..... </div>
⑧ Collimate a prism and press F1 (MEAS) key. When 3 points are set, the area surrounded by the points is calculated and the result will be shown.	Collimate F1	<div style="border: 1px solid black; padding: 5px;"> AREA 0003 11. 144m.sq MEAS --- UNIT --- </div>
*1) Measurement is N-time measurement mode.		

***To change the display unit**

It is possible to change the display area unit.

Operation procedure	Operation	Display
		<div style="border: 1px solid black; padding: 5px;"> AREA 0003 100. 000m.sq MEAS --- UNIT --- </div>
① Press F3 (UNIT) key.	F3	<div style="border: 1px solid black; padding: 5px;"> AREA 0003 100. 000m.sq m.sq ha ft.sq acre </div>

② Press F1 to F4 key to select a unit. *1) Example: F2 (ha)	F2	<table border="1" style="width: 100%; border-collapse: collapse;"> <tr> <td style="width: 50%;">AREA</td> <td style="width: 50%; text-align: right;">0003</td> </tr> <tr> <td></td> <td style="text-align: right;">0.010 ha</td> </tr> <tr> <td>MEAS ---</td> <td>UNIT ---</td> </tr> </table>	AREA	0003		0.010 ha	MEAS ---	UNIT ---
AREA	0003							
	0.010 ha							
MEAS ---	UNIT ---							
*1) m.sq:square meter ha:hectare ft.sq:square feet acre:acre								

11.1.5 Point to Line Measurement

This mode is used to obtain the coordinate data with the origin point A (0,0,0) and the line AB as N axis. Place the 2 prisms at the A and B on the line, and place the instrument at unknown point C. After measuring the 2 prisms, the coordinate and the direction angle of the instrument will be calculated and recorded.

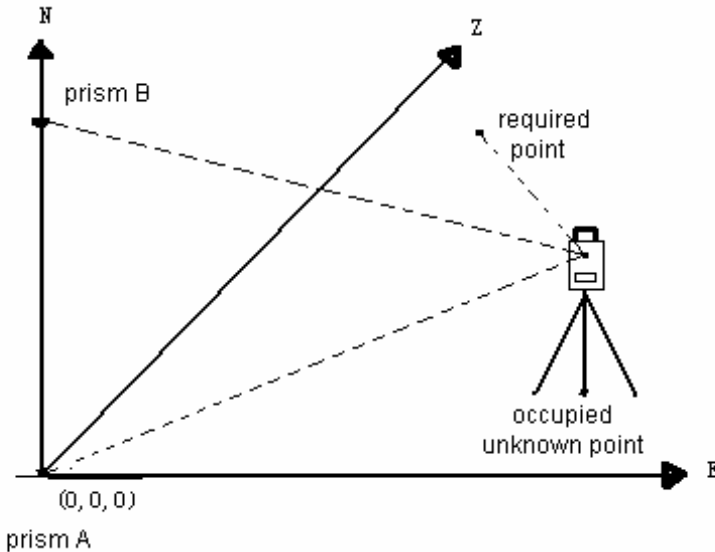

Operation procedure	Operation	Display								
①After pressing MENU key, press F4 (p ↓)key to get the menu on page2.	MENU F4	<table border="1" style="width: 100%; border-collapse: collapse;"> <tr> <td style="width: 50%;">MENU</td> <td style="width: 50%; text-align: right;">2 / 3</td> </tr> <tr> <td>F1: PROGRAMS</td> <td></td> </tr> <tr> <td>F2: GRID FACTOR</td> <td></td> </tr> <tr> <td>F3: ILLUMINATION</td> <td style="text-align: right;">P1 ↓</td> </tr> </table>	MENU	2 / 3	F1: PROGRAMS		F2: GRID FACTOR		F3: ILLUMINATION	P1 ↓
MENU	2 / 3									
F1: PROGRAMS										
F2: GRID FACTOR										
F3: ILLUMINATION	P1 ↓									

<p>② Press the F1 key</p>	<p>F1</p>	<pre> PROGRAMS 1 / 2 F1: REM F2: MLM F3: Z COORD. P1 ↓ </pre>
<p>③ Press F4 (P1 ↓) key</p>	<p>F4</p>	<pre> PROGRAMS 2 / 2 F1: AREA F2: POINT TO LINE P1 ↓ </pre>
<p>④ Press F2 (POINT TO LINE) key</p>	<p>F2</p>	<pre> INSRUMENT HEIGHT INPUT INS.HT: 0.000 m INPUT --- -- ENTER </pre>
<p>⑤ Press F1 (INPUT) key and enter instrument height. Press F4</p>	<p>F1 Enter INS.HT F4</p>	<pre> REFECTOR HEIGHT INPUT R.HT: 0.000 m INPUT --- -- ENTER </pre>
<p>⑥ Press F1 (INPUT) key and enter reflector A (P1) height Press F4</p>	<p>F1 Enter R. HT F4</p>	<pre> POINT TO LINE MEAS.P1 HD : >Sight? [YES] [NO] </pre>
<p>⑦ Collimate prism P1 (Origin) and press F3 (YES) key. Measuring starts.*1) Input display of reflector B (P2) height will be shown.</p>	<p>Collimate P1 F3</p>	<pre> POINT TO LINE MEAS.P1 HD *[n] << m >Measuring </pre> <pre> REFECTOR HEIGHT INPUT R.HT: 0.000 m INPUT --- -- ENTER </pre>
<p>⑧ Press F1 (INPUT) key and enter reflector B (P2) height Press F4</p>	<p>F1 Enter R.HT F4</p>	<pre> POINT TO LINE MEAS. P2 HD : >Sight? [YES] [NO] </pre>

<p>⑨Collimate prism B (P2) and press F3 (YES) . Measuring starts*1) The coordinate data and direction angle of the instrument is caculated and recorded.</p>	<p>Collimate P2 F3</p>	<pre>POINT TO LINE MEAS.P2 HD *[n] << m >Measuring..... set ----- DIST. (P1-P2) 1/2 dHD: 3.254 m dVD: 0.214 m NEZ S.CO --- P1 ↓</pre>
<p>⑩Press F1 (NEZ) key to measure other points.</p>		<pre>N: 0.000 m E : 0.000 m Z : 0.000 m EXIT --- HT MEAS ----- >Measuring</pre>
<p>(11)Collimate prism, press F4 (MEAS) key. Measuring starts *4) The result will be shown.*5)</p>	<p>Collimate P F4</p>	<pre>N: 3.554 m E : 5.254 m Z : 0.000 m EXIT --- HT MEAS</pre>
<p>*1) Measurement is N-time measurement mode. *2) Press F4 (P1 ↓)key to show dSD *3) Press F2 (S.CO) key to show the new occupied data. *4) Measurement is N-time measurement mode. *5) To return to previous mode, press F1 (EXIT) key.</p>		

11.2 Setting the GRID FACTOR

GRID FACTOR can be reset in this menu mode.

For more information, refer to Section 13.2.1 “Setting the GRID FACTOR”

Operation procedure	Operation	Display
<p>①After pressing the MENU key, press the F4 (p ↓) key to get the menu on page 2.</p>	<p>MENU F4</p>	<pre>MENU 2 / 3 F1: PROGRAMS F2: GRID FACTOR F3: ILLUMINATION P1 ↓</pre>

② Press the F2 (GRID FACTOR) key	F2	GRID FACTOR = 0.998823 >MODIFY? [YES] [NO]
③ Press the F3 (YES) key	F3	GRID FACTOR ELEV.-> 1000m SCALE: 0.999000 INPUT --- --- ENTER
④ Press the F1 (INPUT) key and enter Elevation *1) Press the F4 (ENT) key	F1 Enter ELEV F4	GRID FACTOR ELEV.->2000m SCALE:-1.001000 INPUT --- --- ENTER
⑤ Enter Scale Factor in the same way Grid Factor is displayed for 1 to 2 second and display return to menu.	F1 Enter SCALE F4	GRID FACTOR = 1.000685
*1) Refer to Section 5.8 "How to Enter Alphanumeric characters" Input Range: Elevation: -9999 to +9999m (-32.805 to 32.805ft,ft+in) Scale Factor: 0.990000 to 1.010000		

11.3 Setting Illumination of Display and Cross Hairs

Setting ON/OFF for illumination of display (LCD) and reticle.

Example: illumination ON.

Operation procedure	Operation	Display
① After pressing the MENU key, press the F4 (p ↓) key to get the menu on page 2.	MENU F4	MENU 2 / 3 F1: PROGRAMS F2: GRID FACTOR F3: ILLUMINATION P1 ↓
② Press the F3 key The data previously set is shown	F3	ILLUMINATION [OFF] F1: ON F2: OFF

③Press the F1 (ON) key	F1	ILLUMINATION [ON] F1: ON F2: OFF
To return to previous mode, press the ESC key		

12. DATA COLLECTION

Data collect menu operation:

By pressing the **MENU** key, the instrument will be in MENU 1/3 mode.

Press the **F1** (DATA COLLECT) key, the menu of data collect 1/2 will be shown.

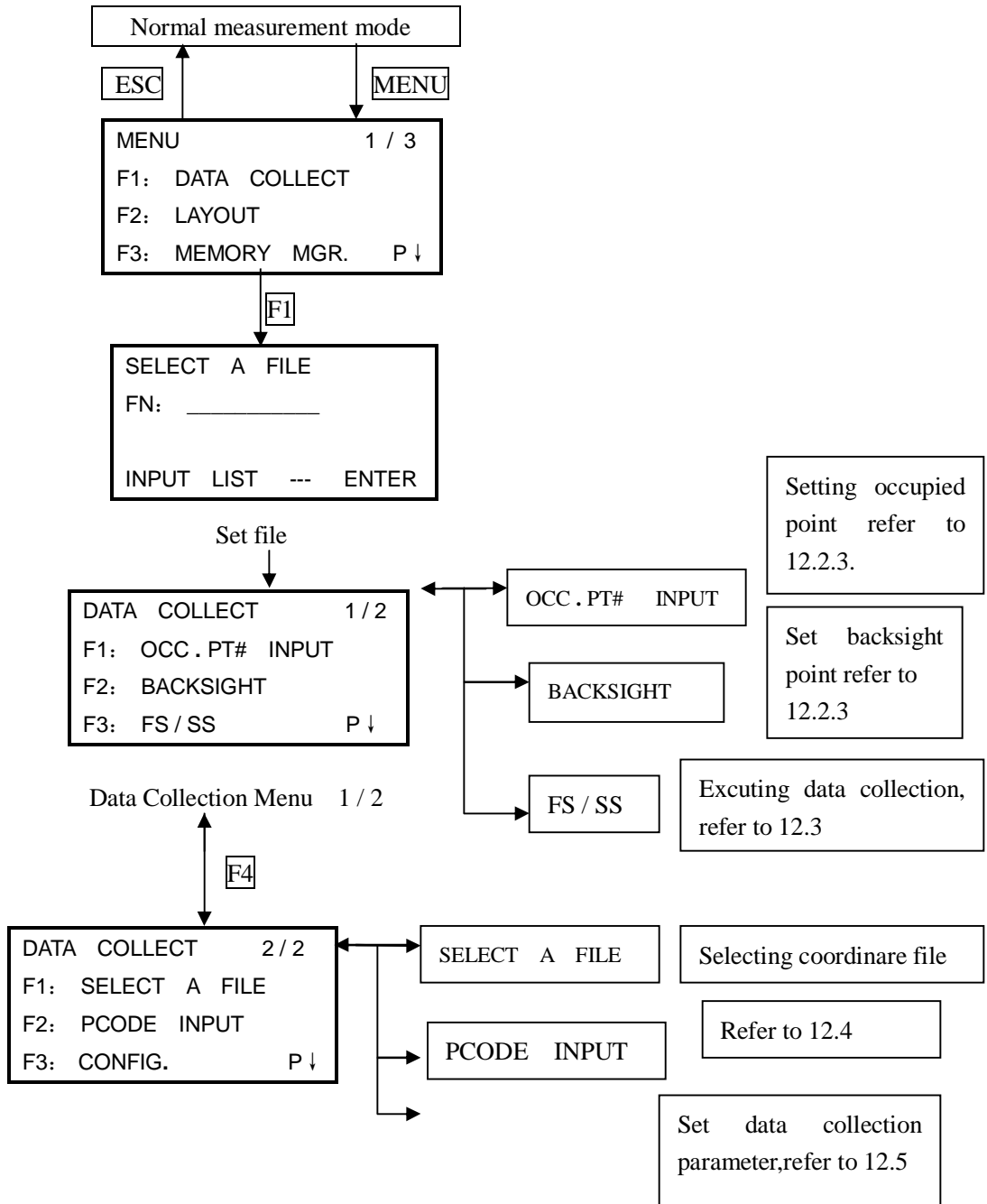

NTS-350R is able to store the measured data into the internal memory
The internal memory is shared by the measured data and the coordinate data files.

Measured data:

The collected data is memorized into files.

The number of measurement points:

(in case of using the internal memory in layout mode) Max. 3500 points

Because the internal memory covers both data collection mode and layout mode, the number of measurement points will be decreased when the layout mode is used.

For the internal memory, refer to Chapter 11“Memory Management Mode”.

- 1) When turning off the power, ensure that you are in the main menu screen or main angle measurement mode. This ensures completion of the memory access process and avoids possible damage to the stored data.
- 2) It is recommended for safety to charge the battery (BT-52QA) beforehand and prepare fully charged spare batteries.

12.1 Operation procedure

1. Select Data Collection File to save data in it.

*** When saving the data, you should select Parameter Setting at first, and select “NO” in “Only save coordinate data or not”.**

2. Select Coordinate Data File so that you can use Occupied Point coordinate data and Backsigh coordinate data. (If coordinate data of known point is not necessary for use , bypass this step)

3. Set Occupied Point includeing Instrument Height, Point Number and Coordinat.

4. Set Backsight Point, Direction and Azimuth.

5. Start collecting and save data.

12.2 Preparation

12.2.1 Selecting a File for Data Collection

A file used by data collection mode must be selected at first.

Select a file before beginning data collection mode because selection screen of a file is displayed. And a selection from data collection menu is possible in the mode.

Operation procedure	Operation	Display
		<pre> MENU 1 / 3 F1: DATA COLLECT F2: LAYOUT F3: MEMORY MGR. P ↓ </pre>
① Press F1 (DATA COLLECT) key from menu 1/3.	F1	<pre> SELECT A FILE FN: _____ INPUT LIST --- ENTER </pre>
② Press F2 (LIST) key to display the list of file *1)	F2	<pre> SOUDATA /M0123 ->*LIFDATA /M0234 DIEDATA /M0355 --- SRCH --- ENTER </pre>
③ Scroll file list by pressing [▼] or [▲] key and select a file to use *2), 3)	[▲] or [▼]	<pre> LIFDATA /M0234 DIEDATA /M0355 ->KLSDATA /M0038 --- SRCH --- ENTER </pre>
④ Press F4 (ENTER) key The file will be set and data collect 1/2 menu will be shown.	F4	<pre> DATA COLLECT 1 / 2 F1: OCC . PT# INPUT F2: BACKSIGHT F3: FS / SS P ↓ </pre>
<p>*1) If you want to make a new file or input file name directly, press F1 (INPUT) key and enter a file name.</p> <p>2) When a file has been selected already, ‘*’ mark is indicated on left of current file name</p> <p>*3) Data in a file shown with arrow can be searched by pressing F2 (SRCH) key. It is possible to select a file from DATA COLLECT 2/2 menu in the same way.</p>		

12.2.2 Selecting a Coordinate File for Data Collection

When coordinate data in a coordinate data file are used for occupied point or backsight point, select a coordinate file from the data collect menu 2/2 beforehand.

Operation procedure	Operation	Display
① Press the F1 (SELECT A FILE) key from DATA COLLECT menu 2/2.	F1	<pre> DATA COLLECT 2 / 2 F1: SELECT A FILE F2: PCODE INPUT F3: CONFIG. P ↓ </pre>
② Press the F2 (COORD DATA) key	F2	<pre> SELECT A FILE 2 / 2 F1: MEAS . DATA F2: COORD . DATA </pre>
③ Select a coordinate file in the same manner as Section 9.2.1 “Selecting a File for Data Collection”		<pre> SELECT A FILE FN: _____ INPUT LIST --- ENTER </pre>

12.2.3 Occupied Point and Backsight Point

The occupied point and direction angle in the data collect mode are linked with the occupied point and it is possible to set or change the occupied point and direction angle from the data collect mode.

Occupied point can be set by two setting methods as follow:

- 1) Setting from the coordinate data stored in the internal memory
- 2) Direct key input

The following three setting methods for backsight point can be selected:

- 1) Setting from the coordinate stored in the internal memory
- 2) Direct key input of coordinate data
- 3) Direct key input of setting angle

Note: See Chapter 11.4 “Coordinate Data Direct Key Input” and 11.7.2 “Loading data”.

Example for setting the occupied point:

(In case of setting occupied point from the coordinate data stored in the internal memory.)

Operation procedure	Operation	Display
① Press the F1 (OCC.PT # INPUT) key from the data collect menu 1/2. The previous data is shown.	F1	<pre>PT# ->PT-01 ID : INS .HT: 0.000 m INPUT SRCH REC OCNEZ</pre>
② Press the F4 (OCNEZ) key	F4	<pre>OCC . PT PT#: PT-01 INPUT LIST NEZ ENTER</pre>
③ Press the F1 (INPUT) key	F1	<pre>OCC . PT PT#: PT-01 BACK SPAC NUM ENTER</pre>
④ Enter PT # , press F4 (ENT) key *1)	Enter PT # F4	<pre>PT# ->PT-11 ID : INS .HT: 0.000 m INPUT SRCH REC OCNEZ</pre>
⑤ Enter ID, INS.HT in the same way*2), 3)	Enter ID Enter INS.HT	<pre>PT# ->PT-11 ID : INS .HT: 1.235 m INPUT SRCH REC OCNEZ</pre>
⑥ Press F3 (REC) key	F3	<pre>PT# ->PT-11 ID : INS .HT-> 1.235 m INPUT SRCH REC OCNEZ >REC? [YES] [NO]</pre>
⑦ Press F3 key. The display returns to the data collect menu 1/2.	F3	<pre>DATA COLLECT 1 / 2 F1: OCC . PT# INPUT F2: BACKSIGHT F3: FS / SS P ↓</pre>

*1) Refer to Section 5.8 “How to Enter Alphanumeric characters”.

*2) ID can be input by inputting a register number linked with PCODE Library
 To show the list of PCODE library, press the **F2** (SRCH) key.

*3) Press the **F3** (REC) key when you do not input the INS HT
 The data recorded in data collect is PT # ,ID and INS.HT
 If point is not found in internal memory “PT # DOES NOT EXIST” is displayed.

Example for setting the direction angle:

The following is to memorize the data of the backsight after setting the backsight point from point number

Operation procedure	Operation	Display
① Press the F2 (BACKSIGHT) key from the data collect menu 1/2. The previous data is shown.	F2	BS# -> PCODE : R . HT : 0.000 m INPUT 0SET MEAS BS
② Press the F4 (BS) key *1)	F4	BACKSIGHT PT# : INPUT LIST NE/AZ [ENT]
③ Press the F1 (INPUT) key	F1	BACKSIGHT PT# : BACK SPAC NUM [ENT]
④ Enter PT # , press the F4 (ENT)key.*2) Enter PCODE, R.HT in the same way.	Enter PT # F4	BS# ->PT-22 PCODE : R . HT : 0.000 m INPUT 0SET MEAS BS
⑤ Press the F3 (MEAS)key	F3	BS# ->PT-22 PCODE : R . HT : 0.000 m *VH SD NEZ ---

<p>⑥Collimate back sight point</p> <p>Select one of the measuring mode and press the soft KEY</p> <p>EXAMPLE: F2 (SD) KEY</p> <p>Measuring starts. Horizontal circle is set to calculated direction angle. Measuring result is memorized and the display return to the data collect menu 1/2.</p>	<p>Collimate</p> <p>F2</p> <p>F4 set</p>	<div style="border: 1px solid black; padding: 5px; margin-bottom: 10px;"> V: 90° 00' 00" HR: 0° 00' 00" SD* <<< m > Measuring... set </div> <div style="border: 1px solid black; padding: 5px;"> DATA COLLECT 1 / 2 F1: OCC . PT# INPUT F2: BACKSIGHT F3: FS / SS P ↓ </div>
<p>**1) Pressing each time the F3 key, the input method changes as Coordinate value, angle, Coordinate point name alternatively.</p> <p>*2) Refer to Chapter 5.8 “How to Enter Alphanumeric characters”.</p> <p>*3) PCODE can be input by inputting a register number linked with PCODE library To show the list of PCODE library, press the F2 (SRCH) key.</p> <p>*4) If point is not found in internal memory “PT # DOES NOT EXIST” is displayed.</p>		

12.2.4 Measuring and Memorizing the Data

Operation procedure	Operation	Display
<p>①Press the F3 (FS/SS) key from the data collect menu 1/2 to measure the unknown point.</p>	<p>F3</p>	<div style="border: 1px solid black; padding: 5px; margin-bottom: 10px;"> DATA COLLECT 1 / 2 F1: OCC . PT# INPUT F2: BACKSIGHT F3: FS / SS P ↓ </div> <div style="border: 1px solid black; padding: 5px;"> PT# -> PCODE: R . HT : 0.000 m INPUT SRCH MEAS ALL </div>
<p>②Press the F1 (INPUT) key and enter PT #</p> <p>*1)</p> <p>Press the F4 (ENT) key</p>	<p>F1 Enter PT #</p> <p>F4</p>	<div style="border: 1px solid black; padding: 5px;"> PT# = PT-01 PCODE : R . HT -> 0.000 m BACK SPAC NUM [ENT]] </div>

		<pre>PT# = PT-01 PCODE: -> R . HT : 0.000 m INPUT SRCH MEAS ALL</pre>
③Enter PCODE, R.HT in the same way *2)	<pre>F1 Enter PCODE F4 F1 Enter R.HT F4</pre>	<pre>PT# ->PT-01 PCODE -> R . HT : 1.200 m INPUT SRCH MEAS ALL VH *SD NEZ OFSET</pre>
④Press the F3 (MEAS) key	F3	
⑤Collimate the target point	Collimate	
⑥Press one of the F1 to F3 key *3) Example: F2 (SD) key Measuring starts. The measuring data is memorized and the display changes to the next point.	F2	<pre>V: 90° 00' 00" HR: 0° 00' 00" SD* [n] <<< m >Measuring... < complete ></pre>
⑦Enter the next point data and collimate the next point.		<pre>PT# ->PT-02 PCODE : R . HT : 1.200 m INPUT SRCH MEAS ALL</pre>

<p>⑧ Press F4 (ALL) key</p> <p>Measuring starts in the same measuring mode of the previous point.</p> <p>Data is recorded</p> <p>Continue the measuring in the same way.</p> <p>Press ESC to finish DATA COLLECT MODE.</p>	<p>Collimate</p> <p>F4</p>	<div style="border: 1px solid black; padding: 5px;"> <p>V: 90° 00' 00"</p> <p>HR: 0° 00' 00"</p> <p>SD* [n] <<< m</p> <p>>Measuring...</p> <hr/> <p style="text-align: center;">< complete ></p> </div>
<p>*1) Refer to Section 5.8 “How to Enter Alphanumeric characters”</p> <p>*2) PCODE can be input by inputting a register number linked with PCODE library To show the list of PCODE library, press the F2 (SRCH) key.</p> <p>*3) The mark “*” indicates the previous measuring mode.</p>		

Searching the recorded data

While executing the Data Collect mode, you can search the recorded data.

Operation procedure	Operation	Display
<p>① While executing the DATA COLLECT mode, press F2 (SRCH) key. *1)</p> <p>The using file name will appear on the top of the right side of the display.</p>	<p>F2</p>	<div style="border: 1px solid black; padding: 5px;"> <p>PT# ->PT-03</p> <p>PCODE :</p> <p>R . HT : 1.200 m</p> <p>INPUT SRCH MEAS ALL</p> </div>
<p>② Select one of three search methods by pressing F1 to F3 key *2)</p>	<p>F1 F3</p>	<div style="border: 1px solid black; padding: 5px;"> <p>SEARCH []</p> <p>F1: FIRST DATA</p> <p>F2: LAST DATA</p> <p>F3: PT# DATA</p> </div>
<p>*1) It is possible to see the PCODE list when the arrow is located beside PCODE or ID.</p> <p>*2) The operation is same as the “SEARCH” in the MEMORY MANAGEMENT MODE For more information, refer to Section 14.2 “Searching Data”.</p>		

Entering PCODE/ID Using PCODE library

While executing the DATA COLLECT mode, you can enter PCODE/ID from PCODE Library.

Operation procedure	Operation	Display
①Move the arrow the PCODE or ID in the DATA COLLECT mode, press the F1 (INPUT) key.	F1 Enter PCODE F4	<div style="border: 1px solid black; padding: 5px;"> PT#: PT-02 PCODE -> R . HT: 1.200 m INPUT SRCH MEAS ALL </div> <div style="border: 1px solid black; padding: 5px;"> PT#: PT-02 PCODE = R . HT: 1.200 m INPUT SRCH MEAS ALL </div>

Entering PCODE/ID from the list of PCODE

You also can enter PCODE/ID from List of PCODE.

Operation procedure	Operation	Display
①Move the arrow to the PCODE or ID in the DATA COLLECT mode, press the F2 (SRCH) key.	F2	<div style="border: 1px solid black; padding: 5px;"> PT#: PT-03 PCODE -> R . HT: 1.200 m INPUT SRCH MEAS ALL </div>
②By pressing the following keys,the register number will increase or decrease. [▲] or [▼] : Increasing or Decreasing one by one	[▲] or [▼]	<div style="border: 1px solid black; padding: 5px;"> ->001: PCODE01 002: PCODE02 EDIT --- CLR ENTER </div> <div style="border: 1px solid black; padding: 5px;"> 021: PCODE21 ->022: 023: KOWL EDIT --- CLR ENTER </div>
③press the F4 (ENTER) key	F4	<div style="border: 1px solid black; padding: 5px;"> PT# ->PT-03 PCODE -> R . HT -> 1.200 m INPUT SRCH MEAS ALL </div>

*1) To edit the PCODE library, press the **F1** (EDIT) key

To delete the PCODE registered with shown an arrow, press the **F3** (CLR) key

PCODE can be edited in DATA COLLECT menu 2/2 or MEMORY MANAGMENT menu 2/3.

12.3 Data Collect Offset Measurement Mode

This mode is useful when it is difficult to set up the prism directly, for example at the center of a tree.

Data Collect Offset Measurement has four measuring methods:

1. Angle Offset Measurement
2. Diatance Offset Measurement
3. Plane Offset Measurement
4. Column Offset Measurement

12.3.1 Angle Offset





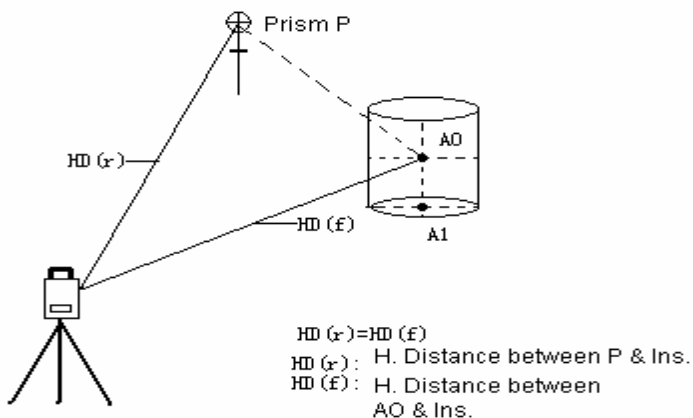

Place the prism at the same horizontal distance from the instrument as that of point A0 to measure. To measure the coordinates of the center position, operate the offset measurement after setting the instrument height/prism height.

When measuring coordinates of ground point A1: Set the instrument height/Prism height

When measuring coordinates of point A0: Set the instrument height only (Set the prism height to 0).



Operation procedure	Operation	Display
① Press F3 (MEAS) key.	F3	<pre>PT# ->PT-01 PCODE -> R.HT -> 1.200 m INPUT SRCH MEAS ALL VH *SD NEZ OFFSET</pre>
② Press F4 (OFFSET) key.	F4	<pre>OFFSET 1/2 F1: ANG. OFFSET F2: DIST. OFFSET F3: PLANE OFFSET P1 ↓</pre>
③ Press F1 (ANG.OFFSET)	F1	<pre>OFFSET-MEASUREMENT HR: 120° 30' 20" SD: m >Sight? [YES] [NO]</pre>
④ Collimate the prism	Collimate P	
⑤ Press F3 (YES) key . Continuous measuring starts.	F3 F4 (SET)	<pre>OFFSET-MEASUREMENT HR: 170° 30' 20" SD*[n] < m >Measuring... SET</pre> <pre>OFFSET-MEASUREMENT HR: 120° 30' 20" SD* 12.453 m >OK? [YES] [NO]</pre>
⑥ Collimate Point A0 using the horizontal motion clamp and horizontal tangent screw.	Collimate A0	<pre>OFFSET-MEASUREMENT HR: 120° 30' 20" SD: 12.453 m >OK? [YES] [NO]</pre>

<p>⑦ Show the horizontal distance of Point A0.</p>		<div style="border: 1px solid black; padding: 5px;"> <p>OFFSET-MEASUREMENT</p> <p>HR: 123° 30' 20"</p> <p>HD: 7.453 m</p> <p>>OK? [YES] [NO]</p> </div>
<p>⑧ Show the relative elevation of point A0.</p> <p>Each time pressing  key, horizontal distance, relative elevation and slope distance are shown in sequence.</p>		<div style="border: 1px solid black; padding: 5px;"> <p>OFFSET-MEASUREMENT</p> <p>HR: 120° 30' 20"</p> <p>VD: 0.853 m</p> <p>>OK? [YES] [NO]</p> </div>
<p>⑨ Show N coordinate of A0 or A1.</p> <p>Each time pressing  key, N,E,Z coordinate are shown in sequence.</p>		<div style="border: 1px solid black; padding: 5px;"> <p>N: - 12.453 m</p> <p>E: - 10.253 m</p> <p>Z: - 1.453 m</p> <p>>OK? [YES] [NO]</p> </div>
<p>⑩ Press F3 (YES) key.</p> <p>The data is recorded and the next measuring point is displayed.</p>		<div style="border: 1px solid black; padding: 5px;"> <p>PT#: PT-11</p> <p>PCODE :</p> <p>R.HT : 1.200 m</p> <p>INPUT SRCH MEAS ALL</p> </div>

12.3.2 Distance Offset Measurement

The measurement of a place apart from a prism is possible by inputting offset horizontal distance of front and back / right and left.

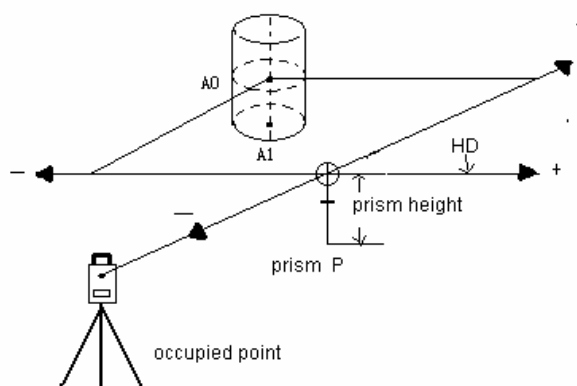

Operation procedure	Operation	Display
① Press F3 (MEAS) key.	F3	<pre>PT# ->PT-01 PCODE -> R.HT -> 1.200 m INPUT SRCH MEAS ALL VH *SD NEZ OFSET</pre>
② Press F4 (OFSET) key.	F4	<pre>OFFSET 1/2 F1: ANG. OFFSET F2: DIST. OFFSET F3: PLANE OFFSET P1 ↓</pre>
③ Press F2 key (DIST. OFFSET)	F2	<pre>DISTANCE OFFSET INPUT R or L HD OHD: 0.000 m INPUT --- SKP ENTER</pre>
④ Press F1 (INPUT) and enter Right and Left direction offset value*1) Press F4 (ENTER) key.	F1 Enter HD F4	<pre>DISTANCE OFFSET INPUT FORWARD HD OHD: 0.000 m INPUT --- SKP ENTER</pre>
⑤ Press F1 (INPUT) and enter Forward direction offset value.*1) Press F4 (ENTER)	F1 Enter HD F4	<pre>DISTANCE OFFSET HR: 120° 30' 20" HD: m MEAS --- --- ---</pre>
⑥ Collimate the Prism P, and press F1	Collimate A0 F1	<pre>DISTANCE OFFSET HR: 120° 30' 20" HD: m >OK? [YES] [NO] < Complete ></pre>

<p>⑦ Press F3 (YES) and the data is recorded. Next offset point number will be displayed.</p>	<p>F3</p>	<p>PT #: PT-10 PCODE: R.HT: 1.354 m INPUT SRCH MEAS ALL</p>
<p>*1) Press F3 (SKP) to skip the entering.</p>		

12.3.3 Plane Offset Measurement

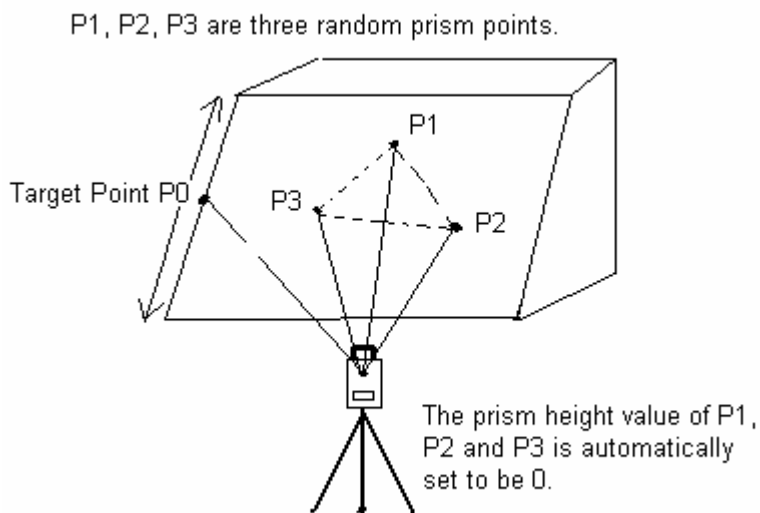

Measuring will be taken for the place where direct measuring cannot be done, for example distance or coordinate measuring for a edge of a plane.

Three random prism points (P1, P2, P3) on a plane will be measured at first in the plane offset measurement to determine the measured plane. Collimate the measuring target point (P0) then the instrument calculates and displays coordinate and distance value of cross point between collimation axis and of the plane.



When setting the coordinate value for the occupied station, refer to Section 7.2 'Setting Coordinate Values of Occupied Point'.

Operation procedure	Operation	Display
① Press F3 (MEAS) key.	F3	<pre>PT# ->PT-01 PCODE -> R.HT -> 1.200 m INPUT SRCH MEAS ALL VH *SD NEZ OFSET</pre>
② Press F4 (OFSET) key.	F4	<pre>OFFSET 1/2 F1: ANG. OFFSET F2: DIST. OFFSET F3: PLANE OFFSET P1 ↓</pre>
③ Press F3 (PLANE OFFSET) key	F3	<pre>PLANE N001# SD*: m MEAS --- --- ---</pre>
④ Collimate P1, press F1 (MEAS) key. N-time measuring will start. After measuring, the display will show the second point measurement.	Collimate P1 F1	<pre>PLANE N001# SD*[n]: <<m Measuring.....</pre>
⑤ Measure the second and third points in the same way. The display change to PT# in the plane offset measurement. Input point number if necessary.	Collimate P2 F1	<pre>PLANE N002# SD*: m MEAS --- --- ---</pre>
	Collimate P3 F1	<pre>PLANE N003# SD*: m MEAS --- --- ---</pre>
⑥ The instrument calculates and displays coordinate and distance value of cross point between collimation axis and of the plane. *1) 2)		<pre>HR: 50° 10' 12" HD: 11.314 m VD*: 4.245 m >OK ? [YES] [NO]</pre>

⑦ Collimate the edge (P0) of the plane *3)	Collimate P0	<table border="1"> <tr><td>HR:</td><td>50° 10' 12"</td></tr> <tr><td>HD:</td><td>11.314 m</td></tr> <tr><td>VD*:</td><td>4.245 m</td></tr> <tr><td>>OK ?</td><td>[YES] [NO]</td></tr> </table>	HR:	50° 10' 12"	HD:	11.314 m	VD*:	4.245 m	>OK ?	[YES] [NO]
HR:	50° 10' 12"									
HD:	11.314 m									
VD*:	4.245 m									
>OK ?	[YES] [NO]									
⑧ Each time press  , horizontal distance, relative elevation and slope distance are shown in sequence.		<table border="1"> <tr><td>V:</td><td>80° 45' 45"</td></tr> <tr><td>HR:</td><td>50° 10' 12"</td></tr> <tr><td>SD*:</td><td>4.245 m</td></tr> <tr><td>>OK ?</td><td>[YES] [NO]</td></tr> </table>	V:	80° 45' 45"	HR:	50° 10' 12"	SD*:	4.245 m	>OK ?	[YES] [NO]
V:	80° 45' 45"									
HR:	50° 10' 12"									
SD*:	4.245 m									
>OK ?	[YES] [NO]									
⑨ Press F3 (YES) and the data is recorded. Next offset point number will be displayed.		<table border="1"> <tr><td>PT#</td><td>->PT-02</td></tr> <tr><td>PCODE</td><td>-></td></tr> <tr><td>R.HT</td><td>-> 1.200 m</td></tr> <tr><td>INPUT SRCH MEAS ALL</td><td></td></tr> </table>	PT#	->PT-02	PCODE	->	R.HT	-> 1.200 m	INPUT SRCH MEAS ALL	
PT#	->PT-02									
PCODE	->									
R.HT	-> 1.200 m									
INPUT SRCH MEAS ALL										
<p>*1) In case the calculation of plane was not successful by the measured three points, error displays. Start measuring over again from the first point.</p> <p>*2) Data display is the mode beforehand of offset measurement mode.</p> <p>*3) Error will displayed when collimate to the direction which does not cross with the determined plane.</p>										

12.3.4 Column Offset Measurement



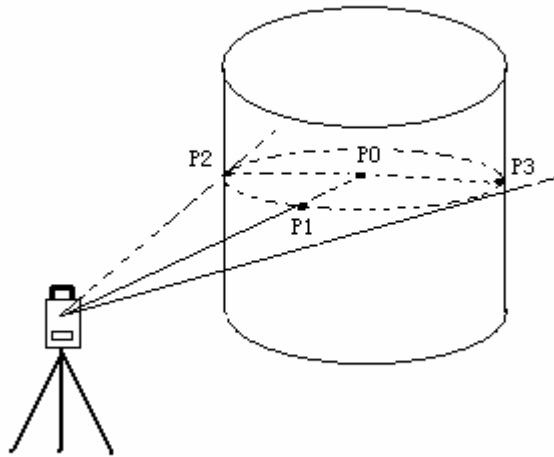

If it is possible to measure circumscription point (P1) of Column directly the distance to the center of the column (P0), coordinate and direction angle can be calculated by measured circumscription points (P2) and (P3).

The direction angle of the center of the column is 1/2 of total direction angle of circumscription points (P2) and (P3).



When setting the coordinate value for the occupied station, refer to Section 7.2 ‘Setting Coordinate Values of Occupied Point’.

Operation procedure	Operation	Display
① Press F3 (MEAS) key.	F3	<pre>PT# ->PT-01 PCODE -> R.HT -> 1.200 m INPUT SRCH MEAS ALL VH *SD NEZ OFFSET</pre>
② Press F4 (OFFSET) key.	F4	<pre>OFFSET 1/2 F1: ANG. OFFSET F2: DIST. OFFSET F3: PLANE OFFSET P1 ↓</pre>
③ Press F4 (P1 ↓) key	F4	<pre>OFFSET 2/2 F1: COLUMN OFFSET P1 ↓</pre>
④ Press F1 (COLUMN OFFSET) key	F1	<pre>COLUMN OFFSET Center HD : m MEAS --- --- ---</pre>

<p>⑤ Collimate the center of the column(P1)and press F1 (MEAS) key. N-time measuring starts. After the measurement, angle measuring display of the left side (P2) will be shown.</p>	<p>Collimate P1 F1</p>	<div style="border: 1px solid black; padding: 5px;"> <p>COLUMN OFFSET 中心 HD*[n]: m >Measuring.....</p> </div>
<p>⑥Collimate the left side of the Column (P2) and press F4 (SET) key. After measurement, anlgge measuring Display of the right side (P3) will be Shown. Collimate the left side of the column (P3) and pressF4 (SET) key</p>	<p>Collimate P2 F4</p> <p>Collimate P3 F4</p>	<div style="border: 1px solid black; padding: 5px;"> <p>COLUMN OFFSET Left HR: 170° 30' 20" --- --- --- SET</p> </div> <div style="border: 1px solid black; padding: 5px;"> <p>COLUMN OFFSET Right HR: 200° 30' 20" --- --- --- SET</p> </div>
<p>⑦ After measurement, the distance between the instrument and center of the column(P0)will be calculated.</p>	<p>Collimate P3 F4</p>	<div style="border: 1px solid black; padding: 5px;"> <p>COLUMN OFFSET HR: 120° 30' 20" HD : 24.251 m >OK? [YES] [NO]</p> </div>
<p>⑧To show the relative elevation VD), press  key. Each time pressing  key, horizontal distance, relative elevation and slope distance are shown in sequence. To show the coordinate of P0, press  key.</p>	<p></p>	<div style="border: 1px solid black; padding: 5px;"> <p>COLUMN OFFSET HR: 120° 30' 20" VD : 24.251 m >OK? [YES] [NO]</p> </div>
<p>⑨Press ESC to exit the column offset mode, and return to the previous mode.</p>	<p>ESC</p>	

12.4 Editing PCODE Library [PCODE INPUT]

PCODE data can be entered into PCODE library in this mode. A Pcode is linked with a number or 1 to 50.

PCODE can be also edited in MEMORY MANAGEMENT menu 2/3 in the same way.

Operation procedure	Operation	Display
① Press the F2 (PCODE INPUT) key from data collect menu 2/3.	F2	<pre> DATA COLLECT 2 / 2 F1: SELECT A FILE F2: PCODE INPUT F3: CONFIG. P ↓ </pre>
② By pressing the following keys, the list will increase or decrease. [▲] or [▼]: Increasing or Decreasing one by one	[▲] or [▼]	<pre> 001: KSIL 002: FW EDIT --- CLR --- </pre>
③ Press the F1 (EDIT) key	F1	<pre> 010: KLIW ->011: KSIL 012: FW EDIT --- CLR --- </pre>
④ Enter PCODE and press the F4 (ENT) key *1)	Input Pcode F4	<pre> 010: KLIW ->011=_____ 012: FW BACK SPAC NUM [ENT] </pre>
*1) Refer to Section 5.8 "How to Enter Alphanumeric characters"		

12.5 Setting Parameter of Data Collection

In this mode, the following setting of data collection mode is possible.

Setting items

Menu	Selecting item	Contents
F1: DIST MODE	FINE / TRACK	Selecting distance measurement mode: Fine / Tracking
F2: MESA SEQ	N-TIMES / REPEAT	Selecting distance measurement mode: N-times / Repeat
F3: SAVE CONFIG	YES / NO	Only save the coordinate data or not?

F1: DIST MODE Default setting: Fine measurement

F2: MESA SEQ Default setting: Repeat distance measurement

F3: SAVE CONFIG Default setting: Only save the measuring data, not the coordinate data

If need to change the setting when collecting data, should set at first.

13. LAYOUT

LAYOUT mode has two functions that are setting of layout points and setting new points using coordinate data in the internal memory. Also, if the coordinate data is not stored in the internal memory, this can be input from keyboard. The coordinate data is loaded from PC to the internal memory via RS-232C.

The coordinate data is memorized into a COORD.DATA file.

For the internal memory, refer to Chapter 11 “MEMORY MANAGEMENT MODE”

The NTS-350 is able to store the coordinate data into the internal memory.

The number of coordinate data

(In case not using the internal memory in the data collect mode) Max. 10800 points.

Because the internal memory covers both data collect mode and layout mode, the number of coordinate data will be decreased when the data collection mode is used.

- 1) When turning off the power, ensure that you are in the main menu screen or main angle measurement mode. This ensures completion of the memory access process and avoids possible damage to the stored data.
- 2) It is recommended for safety to charge the battery (NB20) beforehand and prepare fully charged spare batteries
- 3) When recording new point data, remember to consider the amount of internal memory available.

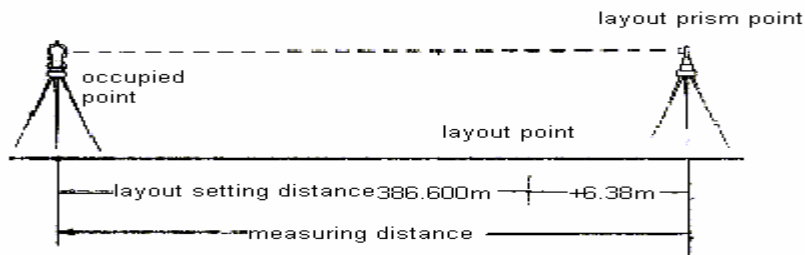

13.1 Setting Parameter of Data Collection

In layout procedure there are following steps:

1. Selecting data collect file to record the data collected.
2. Selecting coordinate data file. Can transfer the occupied point coordinate data and backsight coordinate data.
3. Setting occupied point.
4. Setting backsight point and azimuth angle.
5. Input layout point coordinates, then starts.

13.2 Preparation

13.2.1 Setting the GRID FACTOR

Calculation Formula

1) Elevation factor

$$\text{Elevation factor} = R / (R + \text{ELEV})$$

R: the average radius of the earth

ELEV: the elevation above the mean sea level

2) Scale factor:

Scale factor in the surveying station

3) Grid factor

Grid factor = Elevation factor × Scale factor

Distance calculation

1) Grid distance

$HDg = HD \times \text{Grid factor}$

HDg: Grid distance

HD: Ground distance

2) Ground distance

$HD = HDg / \text{Grid factor}$

How to set Grid Factor

Operation procedure	Operation	Display
① Press the F3 (GRID FACTOR) key from the Layout menu 2/2.	F3	<div style="border: 1px solid black; padding: 5px;"> LAYOUT 2 / 2 F1: SELECT A FILE F2: NEW POINT F3: GRID FACTOR P ↓ </div> <div style="border: 1px solid black; padding: 5px;"> GRID FACTOR = 0.998843 >MODIFY? [YES] [NO] </div>
② Press the F3 (YES) key	F3	<div style="border: 1px solid black; padding: 5px;"> GRID FACTOR ELEV. -> 1000 m SCALE : 0.999000 INPUT --- --- ENTER </div>
③ Press the F1 (INPUT) key and enter Elevation *1) Press the F4 (ENT) key	F1 Enter ELEV F4	<div style="border: 1px solid black; padding: 5px;"> GRID FACTOR ELEV. : 2000 m SCALE -> 1.001000 INPUT --- --- ENTER </div>

<p>④Enter Scale Factor in the same way Grid Factor is display for 1 to 2 second and display returns to Layout menu 2/2.</p>	<p style="text-align: center;"> F1 Enter ELEV F4 </p>	<div style="border: 2px solid black; padding: 5px;"> <p>GRID FACTOR = 1.000685</p> </div>
<p>*1) Refer to Section 5.8 “How to Enter Alphanumeric characters” Input Range: Elevation: -9999 to +9999m (-32805 to +32805ft.ft+in) Scale factor: 0.990000 to 1.010000</p>		

13.2.2 Selecting Coordinate Data File

You can execute a Layout from selected coordinate data file, also you can record New point measured data into the selected coordinate data file.

The only coordinate data file existing can be selected and you can not make a new file in this mode for more information about file, refer to Chapter 11 “MEMORY MANAGEMENT MODE”.

When LAYOUT MODE is begun, a file can be selected in the same way.

Operation procedure	Operation	Display
<p>①Press the F1 (SELECT A FILE) key from the layout menu 2/2.</p>	<p style="text-align: center;">F1</p>	<div style="border: 2px solid black; padding: 5px;"> <p>LAYOUT 2 / 2 F1: SELECT A FILE F2: NEW POINT F3: GRID FACTOR P↓</p> <hr/> <p>SELECT A FILE FN: _____ INPUT LIST --- ENTER</p> </div>
<p>②Press the F2 (LIST) key to display the list of coordinate data file. *1)</p>	<p style="text-align: center;">F2</p>	<div style="border: 2px solid black; padding: 5px;"> <p>COORDDATA /C0352 ->*DATA /C0228 SATADDATA /C0080 --- SRCH --- ENTER</p> </div>

③ Scroll file list by pressing the [▲] or [▼] key and select a file to use *2) 3)	[▲] or [▼]	<pre> *DATA /C0228 SATADDATA /C0080 KLLLSDATA /C0085 --- SRCH --- ENTER </pre>
④ Press the F4 (ENTER) key The file will be set	F4	<pre> LAYOUT 2 / 2 F1: SELECT A FILE F2: NEW POINT F3: GRID FACTOR P ↓ </pre>
<p>*1) If you want to input file name directly, press the [F1](INPUT)key and enter a file name. *2) When a file has been selected already, a mark is indicated on left of current file name. *3) For the file discrimination mark (*, @, &), refer to Section 14.3 "FILE MAINTENANCE"</p>		

13.2.3 Setting Occupied Point

Occupied point can be set by two setting methods as follow:

- 1) Setting from the coordinate data stored in the internal memory
- 2) Direct key input of coordinate data

Setting the occupied point from the internal coordinate data file.

Operation procedure	Operation	Display
① Press the F1 (OCC.PT INPUT) key from the Layout menu 1/2. The previous data is shown.	F1	<pre> OCC.PT PT#: _____ INPUT LIST NEZ ENTER </pre>
② Press the F1 (INPUT) key	F1	<pre> OCC.PT PT# = PT-01 BACK SPAC NUM [ENT] </pre>
③ Enter PT#, press the F4 (ENT) key *1)	Enter PT# F4	<pre> INSTRUMENT HEIGHT INPUT INS. HT: 0.000 m INPUT --- --- ENTER </pre>

<p>④Enter INS HT in the same way The display returns to layout menu 1/2.</p>	<p style="text-align: center;"> F1 Enter INS.HT F4 </p>	<div style="border: 1px solid black; padding: 5px;"> <p>LAYOUT 1 / 2</p> <p>F1: OCC.PT INPUT</p> <p>F2: BACKSIGHT</p> <p>F3: LAYOUT P ↓</p> </div>
<p>*1) Refer to Section 5.8 “How to Enter Alphanumeric characters”.</p>		

Example setting: Setting instrument point coordinates directly

Operation procedure	Operation	Display
<p>①Press the F1 (OCC.PT INPUT) key from the Layout menu 1/2. The previous data is shown.</p>	<p style="text-align: center;">F1</p>	<div style="border: 1px solid black; padding: 5px;"> <p>OCC.PT</p> <p>PT#: _____</p> <p>INPUT LIST NEZ ENTER</p> </div>
<p>②Press the F3 (NEZ) key</p>	<p style="text-align: center;">F3</p>	<div style="border: 1px solid black; padding: 5px;"> <p>N: 0.000 m</p> <p>E: 0.000 m</p> <p>Z: 0.000 m</p> <p>INPUT --- PT# ENTER</p> </div>
<p>③ Press the F1 (INPUT)key and enter coordinate value Press the F4 (ENT)key *1), 2)</p>	<p style="text-align: center;"> F1 Enter coordinate F4 </p>	<div style="border: 1px solid black; padding: 5px;"> <p>N: 10.000 m</p> <p>E: 25.000 m</p> <p>Z: 63.000 m</p> <p>INPUT --- PT# ENTER</p> </div>
<p>④Enter instrument Height in the same way The display returns to layout menu 1/2.</p>	<p style="text-align: center;"> F1 Enter INS.HT F4 </p>	<div style="border: 1px solid black; padding: 5px;"> <p>INSTRUMENT HEIGHT</p> <p>INPUT</p> <p>INS. HT: 0.000 m</p> <p>INPUT --- --- ENTER</p> </div>
<p>⑤Return to Layout Menu.</p>	<p style="text-align: center;"> F1 Enter F4 </p>	<div style="border: 1px solid black; padding: 5px;"> <p>LAYOUT 1 / 2</p> <p>F1: OCC.PT INPUT</p> <p>F2: BACKSIGHT</p> <p>F3: LAYOUT P ↓</p> </div>
<p>*1) Refer to Section 5.8 “How to Enter Alphanumeric characters” *2) It is possible to record the coordinate value. Refer to Chapter 15 “Basic Setting”.</p>		

13.2.4 Setting Backsight Point

The following three setting methods for Backsight point can be selected:

- 1) Setting from the coordinate data file stored in the internal memory.
- 2) Direct key input of coordinate data.
- 3) Direct key input of setting angle.

Example setting: Setting the backsight point from the internal coordinate data file

Operation procedure	Operation	Display
① Press the F2 (BACKSIGHT) key from the Layout menu.	F2	BACKSIGHT PT# : INPUT LIST NE/AZ [ENT]
② Press the F1 (INPUT) key	F1	BACKSIGHT PT#: BA-01 BACK SPAC NUM [ENT]
③ Enter PT#, press the F4 (ENT) key *1)	Enter PT# F4	BACKSIGHT H(B) = 120° 30' 20" >Sight? [YES] [NO]
④ Sight the backsight point and press the F3 (YES) key. The display returns to the layout menu 1/2.	Sight BK F3	LAYOUT 1 / 2 F1: OCC.PT INPUT F2: BACKSIGHT F3: LAYOUT P ↓

*1) Refer to Section 5.8 "How to enter alphanumeric characters".

With each pressing of **F3** key, method of inputting backsight is changed.

1. Use recorded point

2. Enter coordinate directly

3. Enter angle directly

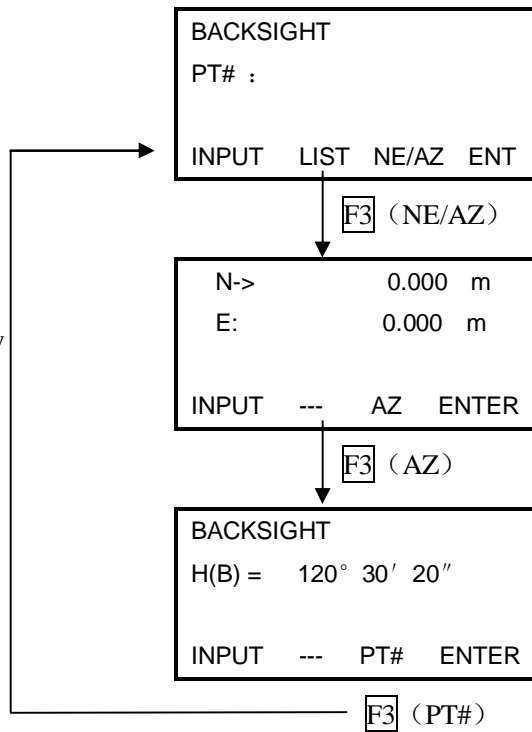

Example: Setting instrument point coordinates directly

Operation procedure	Operation	Display
① Press the F2 (BACKSIGHT) key from the Layout menu 1/2. The previous data is shown	F2	<div style="border: 1px solid black; padding: 5px;"> BACKSIGHT PT# : INPUT LIST NE/AZ ENT </div>
② Press the F3 (NE/AZ) key	F3	<div style="border: 1px solid black; padding: 5px;"> N-> 0.000 m E: 0.000 m INPUT --- PT# ENTER </div>

③ Press the F1 (INPUT) key and enter coordinate value. Press the F4 (ENT) key. *1), 2)	F1 Enter coord. F4	<div style="border: 1px solid black; padding: 5px;"> BACKSIGHT H(B) = 120° 30' 20" >Sight? [YES] [NO] </div>
④ Sight the backsight point	Sight BS	
⑤ Press the F3 (YES) key The display returns to the layout menu 1/2.	F3	<div style="border: 1px solid black; padding: 5px;"> LAYOUT 1 / 2 F1: OCC. PT INPUT F2: BACKSIGHT F3: LAYOUT P ↓ </div>
*1) Refer to Section 5.8 “How to Enter Alphanumeric characters”. *2) It is possible to record the coordinate value. Refer to chapter 15 “Basic Setting”.		

13.3 Executing A Layout

The following methods can be selected for executing a Layout:

- 1) Recalling points from internal memory by point number
- 2) Direct key input of coordinate values

Example setting: Recalling point from internal memory

Operation procedure	Operation	Display
① Press the F3 (LAYOUT) key from the layout menu 1/2.	F3	<div style="border: 1px solid black; padding: 5px; margin-bottom: 10px;"> LAYOUT 1 / 2 F1: OCC. PT INPUT F2: BACKSIGHT F3: LAYOUT P ↓ </div> <div style="border: 1px solid black; padding: 5px;"> LAYOUT PT#: _____ INPUT LIST NEZ ENTER </div>

<p>② Press the F1 (INPUT) key, and enter PT# *1) Press the F4 (ENT) key *2)</p>	<p>F1 Enter PT# F4</p>	<div style="border: 1px solid black; padding: 5px;"> <p>REFLECTOR HEIGHT INPUT R.HT 0.000 m INPUT --- --- ENTER</p> </div>
<p>③ Enter reflector height in the same way When the layout point is set, the instrument will start layout calculation. HR: Calculated horizontal angle of the layout point HD: Calculated horizontal distance from the instrument to the layout point</p>	<p>F1 Enter R.HT F4</p>	<div style="border: 1px solid black; padding: 5px;"> <p>CALCULATED HR: 122° 09' 30" HD: 245.777 m ANGLE DIST --- ---</p> </div>
<p>④ Collimate the prism, and press the F1 (ANGLE) key. PT#: Layout point HR: Measured (Actual) horizontal angle dHR: Horizontal angle to be turned to the layout point =Actual horizontal angle- Calculated horizontal angle Correct direction when dHR=0° 00 ' 00"</p>	<p>Collimate F1</p>	<div style="border: 1px solid black; padding: 5px;"> <p>PT#: LP - 100 HR: 2° 09' 30" dHR: 22° 39' 30" DIST --- NEZ ---</p> </div>
<p>⑤ Press the F1 (DIST) key HD: Measuring (Actual) horizontal distance dHD: Horizontal distance to be turned to the layout point=Actual horizontal distance -Calculated horizontal distance dZ: Vertical distance to be turned to the layout point =Actual vertical distance -Calculated vertical distance</p>	<p>F1</p>	<div style="border: 1px solid black; padding: 5px;"> <p>HD*[r] < m dHD: m dZ: m MODE ANGLE NEZ NEXT</p> </div> <div style="border: 1px solid black; padding: 5px; margin-top: 10px;"> <p>HD* 245.777 m dHD: - 3.223 m dZ: - 0.067m MODE ANGLE NEZ NEXT</p> </div>

<p>⑥ Press the F1 (MODE) key The fine mode measuring starts.</p>	<p>F1</p>	<pre> HD*[r] < m dHD: m dZ: m MODE ANGLE NEZ NEXT </pre> <hr/> <pre> HD* 244.789 m dHD: - 3.213 m dZ: - 0.047m MODE ANGLE NEZ NEXT </pre>
<p>⑦ When the display value dHR, Dhd and DZ are equal to 0, the layout point is established *3)</p>		
<p>⑧ Press the F3 (NEZ) key The coordinate data is shown.</p>	<p>F3</p>	<pre> N: 12.352 m E: 34.286 m Z: 1.5772 m MODE ANGLE --- NEXT </pre>
<p>⑨ Press the F4 (NEXT) key to set next layout point PT# is automatically incremented.</p>	<p>F4</p>	<pre> LAYOUT PT#: _____ INPUT LIST NEZ ENTER </pre>
<p>*1) Refer to Section 5.8 “How to Enter Alphanumeric characters”.</p> <p>*2) Point number could not be entered when data to comply with the coordinate value does not exist in the file.</p> <p>*3) Cut & Fill display function is available. Refer to Chapter 15 “Basic Setting”.</p>		

13.4 Setting A New Point

New point is required, for example, when a layout point cannot be sighted from existing occupied points.

13.4.1 Side Shot Method

Set up the instrument at a known point, and measure the coordinate of the new points by the side shot method.

Operation procedure	Operation	Display
<p>① Press the F4 (↓) key from the layout menu 1/2 to get the layout menu 2/2.</p>	<p>F4</p>	<pre>LAYOUT 1 / 2 F1: OCC.PT INPUT F2: BACKSIGHT F3: LAYOUT P ↓ LAYOUT 2 / 2 F1: SELECT A FILE F2: NEW POINT F3: GRID FACTOR P ↓</pre>
<p>② Press the F2 (NEW POINT) key</p>	<p>F2</p>	<pre>NEW POINT F1: SIDE SHOT F2 : RESECTION</pre>
<p>③ Press the F1 (SIDE SHOT) key</p>	<p>F1</p>	<pre>SELECT A FILE FN: _____ INPUT LIST --- ENTER</pre>
<p>④ Press the F2 (LIST) key to display the list of coordinate data file *1)</p>	<p>F2</p>	<pre>COORDDATA /C0352 ->*DATA /C0228 SATADDATA /C0080 --- SRCH --- ENTER</pre>
<p>⑤ Scroll file list by pressing [▲] or [▼] key and select a file to use *2) 3)</p>	<p>[▲] or [▼]</p>	<pre>*DATA /C0228 ->SATADDATA /C0080 KLLLSDATA /C0085 --- SRCH --- ENTER</pre>
<p>⑥ Press the F4 (ENTER) key. The file will be set.</p>	<p>F4</p>	<pre>SIDE SHOT PT#: INPUT SRCH --- ENTER</pre>

<p>⑦ Press the F1 (INPUT) key, and enter new point name. *4) Press the F4 (ENT) key.</p>	<p>F1 Enter PT# F4</p>	<pre> REFLECTOR HEIGHT INPUT R.HT: 0.000 m INPUT --- --- ENTER </pre>
<p>⑧ Enter reflector height in the same way.</p>	<p>F1 Enter RHT F4</p>	<pre> REFLECTOR HEIGHT INPUT R.HT: 1.356 m >Sight ? [YES] [NO] </pre>
<p>⑨ Collimate the new point, and press the F3 (YES) key. Distance measuring starts.</p>	<p>Collimate F3</p>	<pre> H R: 2° 09' 30" HD* <m VD: m >Measuring... < complete > </pre> <pre> N: 12.352 m E: 34.286 m Z: 1.5772 m >REC ? [YES] [NO] </pre>
<p>⑩ Press the F3 (YES) key *5) The name and coordinate value are stored into COORD DATA The input menu for next point is displayed PT# is automatically incremented.</p>	<p>F3</p>	<pre> SIDE SHOT PT#: NP-101 INPUT SRCH --- ENTER </pre>
<p>*1) If you want to input file name directly, press the F1 (INPUT) key and enter a file name. *2) When a file has been selected already the mark * is indicated on left of current file name. For the file discrimination mark refer to Chapter 14.3 "FILE MAINTENANCE". *3) Data in a file shown with arrow can be searched by pressing F2 (SRCH) key. *4) Refer to Section 5.8 "to Enter Alphanumeric characters". *5) An error will be displayed when the internal memory is full.</p>		

13.4.2 Resection Method

Set up the instrument at a new point, and calculate the coordinate of the new point using the coordinate data for maximum seven known points and the measurement made to these points. By following observation, resection is possible.

*Resection by distance measurement: 2 or more points must be measured.

*Resection by angle measurement: 3 or more points must be measured.

* Resection by angle measurement and distance measurement cannot be used together.

When using resection by angle measurement, the direction of known points should be clockwise or anti-clockwise, and the angle between two points should not exceed 180.

An occupied point coordinate value will be calculated by the method of least squares. (In case that 3 known points are measured by angle measurement only, the value would not be calculated by the method of least squares).

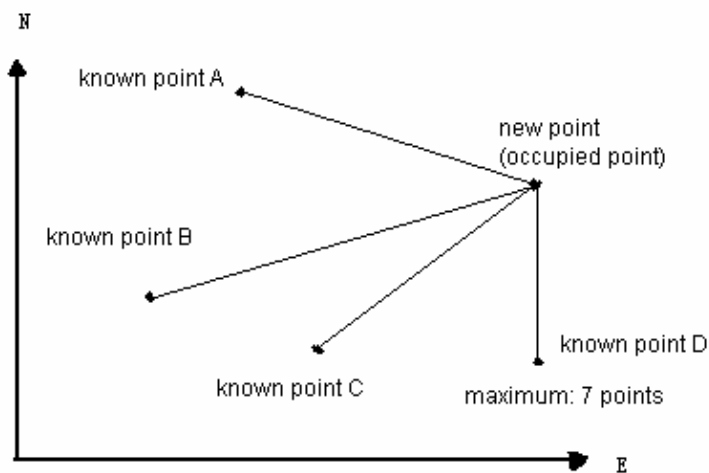

Operating procedure	Operation	Display
① Press the F4 (\downarrow) key from the layout menu 1/2 to get the layout menu 2/2.	F4	<div style="border: 1px solid black; padding: 5px; margin-bottom: 10px;"> LAYOUT 1 / 2 F1: OCC. PT INPUT F2: BACKSIGHT F3: LAYOUT P \downarrow </div> <div style="border: 1px solid black; padding: 5px;"> LAYOUT 2 / 2 F1: SELECT A FILE F2: NEW POINT F3: GRID FACTOR P \downarrow </div>

② Press the F2 (NEW POINT) key	F2	NEW POINT F1: SIDE SHOT F2: RESECTION
③ Press F2 (RESECTION) key	F2	NEW POINT PT #: _____ INPUT SRCH SKP ENTER
④ Press F1 (INPUT) key, and enter the new point name*1) 2) Press F4 (ENT) key.	F1 Enter PT# F4	INSTRUMENT HEIGHT INPUT INS. HT: 0.000 m INPUT --- --- ENTER
⑤ Enter the instrument height in the same way.	F1 Enter INS.HT F4	NO01# PT #: _____ INPUT LIST NEZ ENTER
⑥ Enter the known point A number.*3)	F1 Enter PT# F4	REFLECTOR HEIGHT INPUT R.HT: 0.000 m INPUT --- --- ENTER
⑦ Enter reflector height	F1 Enter R.HT F4	REFLECTOR HEIGHT INPUT R.HT: 1.000 m >Sight? ANG DIST
⑧ Collimate the known point A, press F3 (ANG) or F4 (DIST) key. Example: F4 (DIST)	Collimate F4	H R: 2° 09' 30" HD*[n] <m VD: m >Measuring ... < complete>

<p>Known point B entering display will be shown.</p>		<pre>NO02# PT#: _____ INPUT LIST NEZ ENTER</pre>
<p>⑨ Same as procedure ⑥-⑧ proceed to the known point B. When two points have been measured by F4 (DIST) key, the Residual Error will be calculated*4)</p>	<p>Collimate F3</p>	<pre>SELECT GRID FACTOR F1: USE LAST DATA F2: CALC MEAS.DATA</pre>
<p>⑩ Select GRID FACTOR for calculation of Residual Error by Pressing F1 or F2 *5), Example: F1</p>	<p>F1</p>	<pre>RESIDUAL ERROR dHD = 0.120 m dZ = 0.003 m NEXT --- --- CALC</pre>
<p>(1) Press the F1 (NEXT) key to measure other point. Maximum seven points.</p>	<p>F1</p>	<pre>NO03# PT #: _____ INPUT LIST NEZ ENTER</pre>
<p>(12) Same as procedure ⑥-⑧ proceed to the known point C.</p>		<pre>H R: 2° 09' 30" HD*[n] <m VD: m >Measuring ... < complete></pre>
<p>(13) Press F4 (CACL) key, *6) Standard Deviation will be shown. Unit: (sec) or (mGON) or (mMIL)</p>	<p>F4</p>	<pre>Standard Deviation dHD = 0.120 m dZ = 0.003 m --- ↓ --- NEZ</pre>

<p>(14) Press F2 (↓) key, Standard Deviation of each coordinate will be shown. Unit: (mm) or (inch) The display will be changed alternately by pressing F2 (↓) or (↑)</p>	F2	<pre>SD (n) = 0.120 mm SD (e) = 0.003 mm SD (z) = 0.033 mm --- ↑ --- NEZ</pre>
<p>(15) Press F4 (NEZ) key. Coordinate data of the new point will be shown.</p>	F4	<pre>N: 12.352 m E: 34.286 m Z: 1.5772 m >REC ? [YES] [NO]</pre>
<p>(16) Press F3 (YES) key*7) The new point data will be stored into the coordinate data file and the value of occupied coordinate data will change to that of the calculated New Point.</p>	F3	<pre>NEW POINT F1: SIDE SHOT F2: RESECTION</pre>
<p>*1) See Section 5.8 'How to Enter Aiphanumeric characters' *2) When there is no need to memorize the new point data, press F3 (SKP) key. *3) To enter the known point coordinate data by direct key inputting, press F3 (NEZ) key. *4) RESIDUAL ERROR dHD (Horizontal distance between two known points)= Measured Value – Calculated Value dZ (Z coordinate of the new point caculated from known point A) - (Z coordinte of the new point calculated from Point B) *5) [F1: USE LAST DATA]: Residual Error calculated with the GRID FACTOR already set. [F2: CACL MEAS.DATA]: Residual Error is calculated withour GRID FACTOR already set. In this case, new GRID FACTOR is calculated from measured data and reset. To see GRID FACTOR value, press F3 (G. F.) key.</p>		

*6) In case that the all points are measured by angle measurement only, the following display will be shown.

CACL. Z COORD.
 F1: YES
 F2: NO

[F1: (YES)] : N, E, Z coordinates will be calculated with measured data.

[F2: (NO)] : N, E coordinate will be calculated with measured horizontal angle data.

Z coordinate would not be calculated. (Z=0.000m)

When the distance measurement is done even one point, Z coordinate will be calculated a mean value of relative elevation.

*7) The display shows '>SET?' when **F3** (SKP) key is pressed in Step 4. In this case the new point data is not stored into the coordinate data file, only the value of occupied coordinate data changes to that of the calculated NEW POINT.

View PT# LIST

You can see the PT# List and enter the data from the list, also you can see coordinate data of a point. [Example: Executing Layout Mode]

Operating procedure	Operation	Display
<p>① While executing the Layout Mode, press the F2 (LIST) key. The arrow (->) indicates selected data.</p>	F2	<div style="border: 1px solid black; padding: 5px; margin-bottom: 5px;"> LAYOUT PT#: _____ INPUT LIST NEZ ENTER </div> <div style="border: 1px solid black; padding: 5px;"> [] ->DATA-01 DATA-02 VIEW SRCH --- ENTER </div>
<p>② By pressing the following keys, the list will increase or decrease. [▲] or [▼]: increase or decrease one by one.</p>	[▲] or [▼]	<div style="border: 1px solid black; padding: 5px;"> DATA49 ->DATA-50 DTA-51 VIEW SRCH --- ENTER </div>

<p>③To show the coordinate of the selected data, press F1 (VIEW) . It is possible to scroll the PT# data by pressing [▲] or [▼] key.</p>	<p>F1</p>	<pre>PT# : DATA-50 N: 12.352 m E: 34.286 m Z: 1.5772 m</pre>
<p>④Press ESC key. The display returns to the list.</p>	<p>ESC</p>	<pre>DATA49 ->DATA-50 DTA-51 VIEW SRCH --- ENTER</pre>
<p>⑤Press F4 (ENTER) key. The selected point number is set as PT#.</p>	<p>F4</p>	<pre>REFLECTOR HEIGHT INPUT R.HT: 0.000 m INPUT --- --- ENTER</pre>

14. MEMORY MANAGEMENT MODE

The following items for internal memory are available in this mode

- 1) FILE STATUS: Checking the number of stored data / Remaining internal memory capacity.
- 2) SEARCH: Searching the recorded data
- 3) FILE MAINTAIN: Deleting files/Editing file name
- 4) COORD INPUT: Inputting coordinate data into Coord. data file
- 5) DELETE COORD: Deleting coordinate from Coord. data file
- 6) PCODE INPUT: Inputting PCODE DATA into PCODE library
- 7) DATA TRANSFER: Sending measured data or coordinate data or PCODE Library data/Uploading coordinate data or PCODE library data/Setting
- 8) INITIALIZE: Initializing internal memory

Memory manager menu operation:

By pressing the **MENU** key, the instrument will be in MENU 1/3 mode.

Press the **F3** (MEMORY MGR) key, the menu of MEMORY MGR 1/3 will be shown.

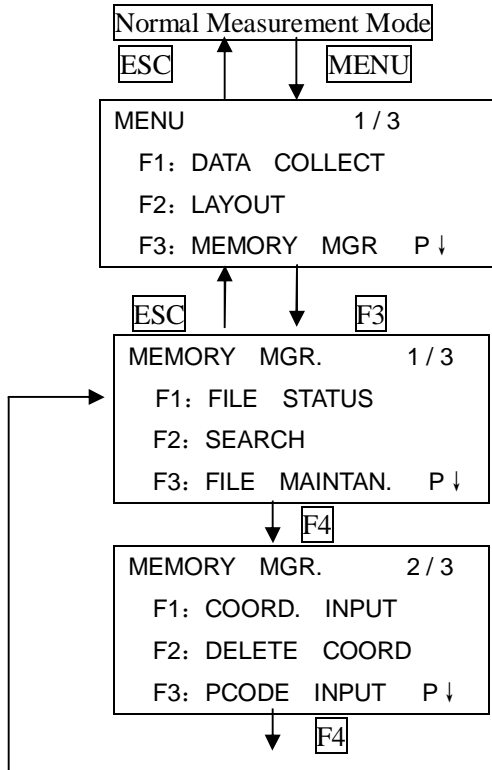

```

MEMORY MGR.      3 / 3
F1: DATA TRANSFER
F2: INITIALIZE
P ↓

```

14.1 Display Internal Memory Status

This mode is used to check the internal memory status.

Operation procedure	Operation	Display
① Press the F3 (MEMORY MGR) key from the menu 1/3.	F3	<pre> MEMORY MGR. 1 / 3 F1: FILE STATUS F2: SEARCH F3: FILE MAINTAN. P ↓ </pre>
② Press the F1 (FILE STATUS) key The total number of stored measured data files and coordinate files are shown.	F1	<pre> FILE STATUS 1 / 2 MEAS. FILE : 3 COORD. FILE: 6 FREE MEM : 85% P ↓ </pre>
③ Press the F4 (p ↓) key. The total number of stored measured data and coordinate data in all files are shown *1)	F4	<pre> FILE STATUS 2 / 2 MEAS. DATA : 0580 COORD. DATA : 0170 FREE MEM : 85% P ↓ </pre>
<p>*1) Each coordinate file has one extra data for working area.</p> <p>The FILE/DATA STATUS display will change alternately by pressing F4 (P ↓) key.</p> <p>To return to MEMORY MGR menu press the ESC key.</p> <p>“FREE MEM” shows the remaining memory.</p>		

14.2 Searching Data

This mode is used to search the recorded file data in the Data Collect or Layout mode.

The following 3 search methods in each type of files can be selected:

1. First data search
2. Last data search
3. Point number search (MEAS. DATA, COORD. DATA)

Number search (PCODE LIB)

MEAS DATA: Measured data in the data collect mode

COORD DATA: Coordinate data for layout, control points and new point data measured in the layout mode

PCODE LIB: The data which are registered with a number from 1 to 50 in Point code library.

14.2.1 Measured Data Searching

Operation procedure	Operation	Display
① Press the F3 (MEMORY MGR) key from the menu 1/3.	F3	MEMORY MGR. 1 / 3 F1: FILE STATUS F2: SEARCH F3: FILE MAINTAN. P ↓
② Press the F2 (SEARCH) key	F2	SEARCH F1: MEAS. DATA F2: COORD. DATA F3: PCODE LIB
③ Press the F1 (MEAS DATA) key	F1	SELECT A FILE FN: _____ INPUT LIST --- ENTER
④ Press the F1 (INPUT) key and enter File Name. Press the F4 (ENT) key, *1) 2)	F1 Enter FN F4	MEAS. DATA SEARCH F1: FIRST DATA F2: LAST DATA F3: PT# DATA
⑤ Press the F3 (PT#DATA) key	F3	PT# DATA SEARCH PT#: _____ INPUT --- --- ENTER
⑥ Press the F1 (INPUT) key and enter PT#. Press the F4 (ENT) key *1	F1 Enter PT# F4	PT# SOUT - 104 1 / 2 V : 90° 26' 05" HR: 134° 30' 20" SD: 13.550 m P ↓

<p>⑦ Press the F4 (↓) key to scroll data for selected point.</p>	<p>F4</p>	<pre>PT# SOUT- 104 2 / 2 PCODE: R. HT : 1.300 m EDIT P ↓</pre>
<p>*1) Refer to Section 5.8 “How to enter alphanumeric characters”.</p> <p>*2) To show the file list, press the F2 (LIST) key.</p> <p>Press the ▲ or ▼ key to scroll to next or previous point.</p> <p>To search MEAS DATA of the same point number, press ▲ or ▼ key.</p>		

Edit Measured Data in Search Mode

In this mode PT# , ID, Pcode, Instrument Height and Prism Height can be modified, but the measured data can not.

Operation procedure	Operation	Display
		<pre>PT# SOUT- 104 2 / 2 PCODE : R. HT : 1.300 m EDIT P ↓</pre>
<p>① Press F1 (EDIT) in data display P2.</p>	<p>F1</p>	<pre>PT# -> SOUT- 104 2 / 2 PCODE : R.HT: 1.300 m INPUT --- --- ENTER</pre>
<p>② Press ▲ or ▼ key to select the data item to be modified.</p>	<p>▲ ▼</p>	<pre>PT# SOUT- 104 2 / 2 PCODE : R.HT -> 1.300 m INPUT --- --- ENTER</pre>
<p>③ Press F1 (INPUT) key, Enter data. Press F4 (ENTER) key. *1)</p>	<p>F1 Enter data F4</p>	<pre>PT# SOUT- 104 2 / 2 PCODE : R.HT -> 1.300 m INPUT --- --- ENTER</pre>
<p>④ Press F4 (ENTER) key</p>	<p>F4</p>	<pre>PT# SOUT- 104 2 / 2 PCODE : R.HT : 1.300 m EDIT P ↓</pre>
<p>*1) Refer to Section 5.8 “How to enter alphanumeric characters”.</p>		

14.2.2 Coordinate Data Searching

Example searching: Point number searching

Operation procedure	Operation	Display
① Press the F3 (MEMORY MGR) key from the menu 1/3.	F3	MEMORY MGR. 1 / 3 F1: FILE STATUS F2: SEARCH F3: FILE MAINTAN. P ↓
② Press the F2 (SEARCH) key	F2	SEARCH F1: MEAS. DATA F2: COORD. DATA F3: PCODE LIB
③ Press the F2 (COORD DATA) key	F2	SELECT A FILE FN: _____ INPUT LIST --- ENTER
④ Press the F1 (INPUT) key and enter File Name. Press the F4 (ENT) key, *1)	F1 Enter FN F4	COORD DATA SEARCH F1: FIRST DATA F2: LAST DATA F3: PT# DATA
⑤ Press the F3 (PT#DATA) key	F3	PT# DATA SEARCH PT#: _____ INPUT --- --- ENTER
⑥ Press the F1 (INPUT) key and enter PT#. Press the F4 (ENT) key *1)	F1 Enter PT# F4	PT#:DATA50 N: 12.352 m E: 34.286 m Z: 1.5772 m
*1) Refer to Section 5.8 "How to Enter Alphanumeric characters". Press the [▲] or [▼] key to scroll to next or previous point.		

14.2.3 PCODE LIBRARY Searching

Example searching: Register number searching

Operation procedure	Operation	Display
① Press the F3 (MEMORY MGR) key from the menu 1/3.	F3	MEMORY MGR. 1 / 3 F1: FILE STATUS F2: SEARCH F3: FILE MAINTAN. P ↓
② Press the F2 (SEARCH) key.	F2	SEARCH F1: MEAS. DATA F2: COORD. DATA F3: PCODE LIB
③ Press the F3 (PCODE LIB) key.	F3	PCODE NO. SEARCH F1: FIRST DATA F2: LAST DATA F3: NO. DATA
④ Press the F3 (NO SEARCH) key	F3	PCODE NO. SEARCH NO.: INPUT --- --- ENTER
⑤ Press the F1 (INPUT) key and enter register number. Press the F4 (ENT) key *1) The number and linked data will be shown	F1 Enter register no. F4	011: KKIE ->012: AKOT 013: LSE EDIT --- CLR ---
*1) Refer to Section 5.8 "How to Enter Alphanumeric characters" Press the [▲] or [▼] key to scroll to next or PCODE data. To delete the PCODE data, press the F3 (CLR) key.		

14.3 File Maintenance

In this mode, the following items are available:

Renaming file name /Searching data in a file /Deleting files

FILE MAINTAN menu

MEMORY MGR.	1 / 3
F1: FILE STATUS	
F2: SEARCH	
F3: FILE MAINTAN.	P ↓

@DATA	/C0123
->DATA0102	/M0220
&SOUDATA	/C0010
REN SRCH DEL	---

Pressing **F3** (FILE MAINTAN) key from MEMORY MANAGER menu 1/3, file list will be shown.

File discrimination mark (*, @, &) is placed before file name indicates the file status.

For measured data file:

“*”: Selected file for DATA COLLECT mode.

For coordinate data file:

“*”: Selected file for Layout mode

“@”: Selected coordinate file for DATA COLLECT mode

“&”: Selected coordinate file for both LAYOUT and DATA COLLECT mode

Data discrimination character (M, C)

Data discrimination character (M, C) placed before four figures indicates the type of data

“M”: Measured data

“C”: Coordinate data

Four figures means the total number of data in the file.

(Coordinate data file has an extra data for working)

Press the [**▲**] or [**▼**] key to scroll to next file.

14.3.1 Renaming a File

An existing file in internal memory can be renamed.

Operation procedure	Operation	Display
① Press the F3 (FILE MAINTAN) key from the Memory Management menu 1/3.	F3	<pre> ->@KIDATA /C0123 DATA0102 /M0220 &SOUDATA /C0010 REN SRCH DEL --- </pre>
② Select a file by pressing [▲] or [▼] key.	[▲] or [▼]	<pre> @KIDATA /C0123 ->DATA0102 /M0220 &SOUDATA /C0010 REN SRCH DEL --- </pre>
③ Press the F1 (REN) key	F1	<pre> @KIDATA /C0123 = DATA0102__ /M0220 &SOUDATA /C0010 BACK SPAC NUM [ENT] </pre>
④ Enter new file name Press the F1 (ENT)key *1)	Enter FN F4	<pre> @KIDATA /C0123 ->DATA0100 /M0220 &SOUDATA /C0010 REN SRCH DEL --- </pre>
<p>*1) Refer to Section 5.8 “How to Enter Alphanumeric characters”.</p> <p>Existing file name cannot be available.</p> <p>To return to the FILE MAINTAN Menu, press the [ESC] key.</p>		

14.3.2 Searching Data in a File

An existing file in internal memory can be searched.

Operation procedure	Operation	Display
① Press the F3 (FILE MAINTAN) key from the Memory manager menu 1/3.	F3	<pre> ->@KIDATA /C0123 DATA0102 /M0220 &SOUDATA /C0010 REN SRCH DEL --- </pre>
② Select a file to search by pressing [▲] or [▼] key.	[▲] or [▼]	<pre> @KIDATA /C0123 ->DATA0102 /M0220 &SOUDATA /C0010 REN SRCH DEL --- </pre>
③ Press the F2 (SRCH)key.	F2	<pre> @KIDATA /C0123 ->DATA0102 /M0220 &SOUDATA /C0010 REN SRCH DEL --- </pre>

④Select searching method by pressing the F1 to F3 key. *1)	F1 - F3	SEARCH [DATA0102] F1: FIRST DATA F2: LAST DATA F3: PT# DATA
*1) Because procedures from next are same as procedures of Section 14.2 “Searching Data”, refer to Section 14.2 “Searching Data”. To return to the FILE MAINTAN Menu, press the ESC key.		

14.3.3 Deleting a File

This mode erases a file from internal memory, only one file can be erased at a time.

Operation procedure	Operation	Display
①Press the F3 (FILE MAINTAN)key from the Memory manager menu 1/3.	F3	->@KIDATA /C0123 DATA0102 /M0220 &SOUDATA /C0010 REN SRCH DEL ---
②Select a file to delete by pressing [▲] or [▼]key.	[▲]or[▼]	@KIDATA /C0123 ->DATA0102 /M0220 &SOUDATA /C0010 REN SRCH DEL ---
③Press the F3 (DEL) key.	F3	@KIDATA /C0123 ->DATA0102 /M0220 &SOUDATA /C0010 >DELETE? [NO] [YES]
④Confirm the deleting, and press the F4 (YES) key.	F4	@KIDATA /C0123 &SOUDATA /C0010 DWDATA /C0237 REN SRCH DEL ---
To return to the FILE MAINTAN Menu, press the ESC key.		

14.4 Coordinate Data Direct Key Input

Coordinate data for the layout point or control point can be input directly from the keyboard. The data can be stored into a file in the internal memory.

Operation procedure	Operation	Display
① Press the F3 (MEMORY MGR) key from the menu 1/3.	F3	MEMORY MGR. 1 / 3 F1: FILE STATUS F2: SEARCH F3: FILE MAINTAN. P ↓
② Press the F4 (p ↓) key.	F4	MEMORY MGR. 2 / 3 F1: COORD. INPUT F2: DELETE COORD F3: PCODE INPUT P ↓
③ Press the F1 (COORD INPUT) key.	F1	SELECT A FILE FN: _____ INPUT LIST --- ENTER
④ Press the F1 (INPUT) key and enter File Name you want to input. Press the F4 (ENT) key *1)	Enter PN F1 F4	COORD. DATA INPUT PT#: _____ INPUT LIST --- ENTER
⑤ Press the F1 (INPUT) key and enter PT#. Press the F4 (ENT) key *1)*1)	Enter PT# F1 F4	N: 12.352 m E: 34.286 m Z: 1.5772 m INPUT --- --- ENTER
⑥ Enter coordinate data in the same way. Next input display is shown, point number (PT#) is automatically incremented	Enter Coord. F4	COORD. DATA INPUT PT#: - 100 INPUT LIST --- ENTER
*1) Refer to Section 5.8 "How to Enter Alphanumeric characters"		

14.5 Deleting a Coordinate Data from a File

Coordinate data in a file can be erased

Operation procedure	Operation	Display
① Press the F3 (MEMORY MGR) key from the menu 1/3.	F3	MEMORY MGR. 1 / 3 F1: FILE STATUS F2: SEARCH F3: FILE MAINTAN. P ↓
Press the F4 (P ↓) key	F4	MEMORY MGR. 2 / 3 F1: COORD. INPUT F2: DELETE COORD F3: PCODE INPUT P ↓
③ Press the F2 (DELETE COORD) key.	F2	SELECT A FILE FN: _____ INPUT LIST --- ENTER
④ Press the F1 (INPUT) key and enter File Name. Press the F4 (ENT) key *1)	Enter PN F1 F4	DELETE COORD PT#: _____ INPUT LIST --- ENTER
⑤ Press the F1 (INPUT) key and enter PT#. Press the F4 (ENT) key *1)	Enter PT# F1 F4	N: 12.352 m E: 34.286 m Z: 1.5772 m >DELETE ? [YES] [NO]
⑥ Confirm the data and press the F3 (YES) key Deleting starts. The display will return to the previous display.	F3	
*1) Refer to Section 5.8 "How to Enter Alphanumeric characters"		

14.6 Editing PCODE Library

PCODE data can be entered into PCODE Library in this mode.

A PCODE is linked with a number or 1 to 50.

PCODE can be also edited in DATA COLLECT menu 2/3 in the same way.

Operation procedure	Operation	Display
① Press the F3 (MEMORY MGR) key from the menu 1/3.	F3	MEMORY MGR. 1 / 3 F1: FILE STATUS F2: SEARCH F3: FILE MAINTAN. P ↓
② Press the F4 (p ↓) key.	F4	MEMORY MGR. 2 / 3 F1: COORD. INPUT F2: DELETE COORD F3: PCODE INPUT P ↓
③ Press the F3 (PCODE INPUT) key	F3	->001: 002: DSAIK EDIT --- CLR ---
④ By pressing the following keys, the list will increase or decrease. [▲] or [▼]: Increasing or Decreasing one by one.	[▲] [▼]	001: ->002: DSAIK 003: LISS EDIT --- CLR ---
⑤ Press the F1 (EDIT) key	F1	001: ->002: _____ 003: LISS BACD SPAC NUM [ENT]
⑥ Enter PCODE and press the F4 (ENT)key *1)	Enter PCODE F4	001: ->002: DSAIK 003: LISS EDIT --- CLR ---
*1) Refer to Section 5.8 "How to Enter Alphanumeric characters".		

14.7 Data Communication

You can send a data file stored in the internal memory to a computer directly. Also you can directly load a coordinate data file and PCODE Library data to the internal memory from the computer.

Data Communication Menu:

DATA TRANSFER F1: SEND DATA F2: LOAD DATA F3: COMM. PARAMETERS

Note: When communicating the data, you should check whether the cable is connected well and whether the parameter settings in PC and Total Station are consistent.

14.7.1 Sending Data

Example: Sending a measured data file

Operation procedure	Operation	Display
① Press the F3 (MEMORY MGR) key from the menu 1/3.	F3	MEMORY MGR. 1 / 3 F1: FILE STATUS F2: SEARCH F3: FILE MAINTAN. P ↓
② Press the F4 (p ↓) key twice.	F4 F4	MEMORY MGR. 3 / 3 F1: DATA TRANSFER F2: INITIALIZE P ↓
③ press the F1 (DATA TRANSFER) key.	F1	DATA TRANSFER F1: SEND DATA F2: LOAD DATA F3: COMM. PARAMETERS
④ Press the F1 key	F1	SEND DATA F1: MEAS. DATA F2: COORD. DATA F3: PCODE DATA
⑤ Select the type of data to send by pressing F1 - F3 key Example: F1 (MEAS DATA)	F1	SELECT A FILE FN: _____ INPUT LIST --- ENTER
⑥ Press the F1 (INPUT) key and enter File Name you want to send, press the F4 (ENT) key *1) 2)	F1 Enter FN F4	SEND MEAS. DATA >OK ? --- --- [YES] [NO]

⑦ Press the F3 (YES) key, *3) The sending starts. The display will return to menu	F3	<pre> SEND MEAS. DATA < SEND DATA! ,> STOP </pre>
*1) Refer to Section 5.8 “How to Enter Alphanumeric characters”. *2) To scroll the data, press the [▲] or [▼] key. To show the file list, press the F2 (LIST) key *3) To cancel the sending, press the F4 (STOP) key.		

14.7.2 Loading Data

Coordinate data files and PCODE Library data can be loaded from PC.

Example: Loading a coordinate data file.

Operation procedure	Operation	Display
① Press the F3 (MEMORY MGR) key from the menu 1/3.	F3	<pre> MEMORY MGR. 1 / 3 F1: FILE STATUS F2: SEARCH F3: FILE MAINTAN. P ↓ </pre>
② Press the F4 (p ↓) key twice.	F4 F4	<pre> MEMORY MGR. 3 / 3 F1: DATA TRANSFER F2: INITIALIZE P ↓ </pre>
③ Press the F1 (DATA TRANSFER) key	F1	<pre> DATA TRANSFER F1: SEND DATA F2: LOAD DATA F3: COMM. PARAMETERS </pre>
④ Press the F2 key	F2	<pre> LOAD DATA F1: COORD. DATA F2: PCODE DATA </pre>
⑤ Select the type of data to load by pressing F1 or F2 key. Example: F1 (COORD DATA)	F1 Enter FN	<pre> COORD. FILE NAME FN: _____ INPUT --- --- ENTER </pre>

⑥ Press the F1 (INPUT) key and enter New File Name you want to receive. Press the F3 (ENT) key*1)	F4 F3	LOAD COORD. DATA >OK ? --- --- [YES] [NO]
⑦ Press the F3 (YES) key *2) The loading starts The display will return to menu.		LOAD DATA < Waiting Data! > STOP
*1) Refer to Section 5.8 "How to Enter Alphanumeric characters". *2) To cancel the loading, press the F4 (STOP) key.		

14.7.3 Setting Parameter of Data Communication

Example setting Baud rate: 4800

Operation procedure	Operation	Display
① Press the F3 (MEMORY MGR) key from the menu 1/3.	F3	MEMORY MGR. 1 / 3 F1: FILE STATUS F2: SEARCH F3: FILE MAINTAN. P ↓
② Press the F1 (p ↓) key twice.	F4 F1	MEMORY MGR. 3 / 3 F1: DATA TRANSFER F2: INITIALIZE P ↓
③ Press the F1 (DATA TRANSFER) key.	F1	DATA TRANSFER F1: SEND DATA F2: LOAD DATA F3: COMM. PARAMETERS
④ Press the F1 (COMM PARAMETERS) key	F1	COMM. PARAMETERS F1: BAUD RATE F2: PROTOCOL F3: CHAR. /PARITY
⑤ Press the F1 (BAUD RATE) key	F1	BAUD RATE SELECT BAUT.RATE: 1200 b/s 1200 2400 4800 ENT

⑥Select 4800 by pressing F3 key	F3	BAUD RATE SELECT BAUT.RATE: 4800 b/s 1200 2400 4800 ENT
⑦Press the F4 (ENTER) key.	F4	COMM. PARAMETERS F1: BAUD RATE F2: PROTOCOL F3: CHAR. /PARITY
*1) To cancel setting, press the [ESC]key.		

14.8 Initialization

This mode is used to initialize the internal memory. Following data can be initialized:

FILE AREA: All files of measuring data and coordinate data.

PCODE DATA: PCODE LIST

ALL DATA: FILE DATA and PCODE DATA

Example initialization: ALL DATA (FILL data and PCODE data)

Operation procedure	Operation	Display
①Press the F3 (MEMORY MGR) key from the menu 1/3.	F3	MEMORY MGR. 1 / 3 F1: FILE STATUS F2: SEARCH F3: FILE MAINTAN. P ↓
②Press the F4 (p ↓) key twice	F4 F4	MEMORY MGR. 3 / 3 F1: DATA TRANSFER F2: INITIALIZE P ↓
③Press the F2 (INITIALIZE) key	F2	INITIALIZE F1: FILE AREA F2: PCODE LIST F3: ALL DATA
④ Select the data to initialize by pressing one of the F1 to F3 key Example: F3 (ALL DATA)	F3	INITIALIZE DATA ERASE ALL DATA! >OK ? [NO] [YES]

<p>⑤ Confirm the erase data, press the F4 (YES) key. Initializing will start. The display returns to menu.</p>	<p>F4</p>	<div data-bbox="814 193 1199 363" style="border: 1px solid black; padding: 5px;"> <p>INITIALIZE DATA</p> <p>< Initializing! ></p> <p>< please waiting ></p> </div> <div data-bbox="814 407 1199 569" style="border: 1px solid black; padding: 5px;"> <p>INITIALIZE</p> <p>F1: FILE AREA</p> <p>F2: PCODE LIST</p> <p>F3: ALL DATA</p> </div>
---	------------------	--

Note: that the following data are not initialized even if initialization is executed:
 Coordinates of the instrument, instrument height and Reflector height.

15. BASIC SETTING

15.1 The Options of Basic Setting

Turn on the instrument while pressing the **F4** key, then the following settings are available.

Menu	Item	Option	Content
UNIT SET	FEET	F1: US SURVEY F2: INTERNATIONAL	Select M/FT conversion factor U.S. SURVEY FEET: 1M=3.28033333333333ft INTERNATIONAL FEET : 1M=3.280839895013123ft
	ANGLE	DEG (360°) GON (400G) MIL (6400M)	Select angle measurement unit DEG/GON/MIL
	DISTANCE	m ft ft+in	Select distance measurement unit: m / ft / ft+in
	TEMPERATURE AIR PRESSURE	Temperature: °C / °F Air Pressure: hPa /mmHg/inHg	Select temp. unit: °C / °F Select air pressure unit: hPa /mmHg/inHg
Mode Set	POWER ON MODE	ANGLE MEAS. DISTANCE MEAS	Select to enter measurement mode for angle or distance when the power is turned on.
	FINE/TRACK	FINE/ TRACK	Select Fine/Tracking mode in the distance measurement mode, when the power is turned on.
	HD&VD/SD	HD& VD /SD	Specify which is displayed first, horizontal and vertical distance or slope distance when the power is turned on.
	V ANGLE Z0 / H0	ZENITH 0 / HORIZONTAL 0	Select the vertical angle reading from the zenith or the level.
	N-TIMES/ REPEAT	N-TIMES / REPEAT	Select the measurement mode for distance when the power is turned on.

	TIMES OF MEAS	0-99	Set number of times for distance measurement. When setting number of times is 1, it is single measurement.
	EDM OFF TIME	0-99	The time when EDM is out off from distance measurement is complete can be changed. The function is effective for shortening the first measuring time when distance measurement is started from distance measurement completing state.
	GRID FACTOR	USE/NOT USE	Select to use or not to use the Grid Factor
	NEZ/ENZ	NEZ/ENZ	Select the coordinate displayed as NEZ or ENZ
Others Set	H-ANGLE BUZZER	ON / OFF	Specify whether the buzzer sounds or not ofr every horizontal angle 90° .
	EDM BUZZER	ON/ OFF	Buzzer sounds when receving the reflected signal.
	W-CORRECTION	0.14/0.20/OFF	Set the correction of refraction and earth curvature.

16. CHECK AND ADJUSTMENT

The instrument has been checked and adjusted strictly in the factory and meet the quality requirement. But the long distance transportation and the change of the environment will have great influence on internal structure the instrument. So before using, the instrument should be checked and adjusted according the items of this section.

16.1 Plate Vial

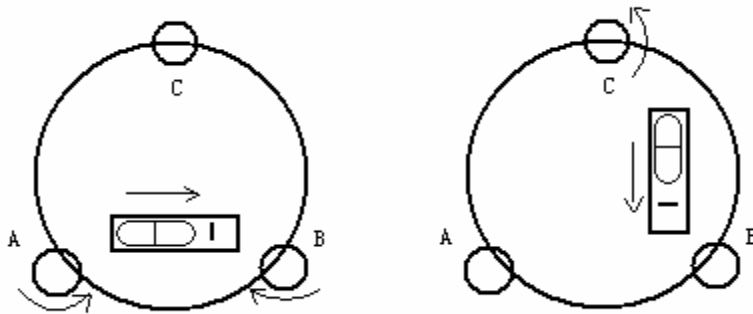

Inspection

Refer to Section 2.4 “Leveling by using the plate vial”.

Adjustment

1. If the bubble of the plate vial moves from the center, bring it half way back to the center by adjusting the leveling screw, which is parallel to the plate vial. Correct the remaining half by adjusting the screw of plate vial with adjusting pin.

2. Confirm whether the bubble does is in the center by rotating the instrument 180° . If not, repeat Procedure (1).

3. Turn the instrument 90° and adjust the third screw to center the bubble in the vial.

Repeat inspection and adjustment steps until the bubble remains in center with the vial in any direction.

16.2 Circular Vial

Inspection

No adjustment is necessary if the bubble of the circular vial is in the center after inspection and adjustment of the plate vial.

Adjustment

If the bubble of the circular vial is not in the center, bring the bubble to the center by using the adjusting pin or hexagon wrench to adjust the bubble adjusting screw. First loosen the screw opposite to the offset side, and then tighten the other adjusting screw on the offset side, bringing the bubble to the center. After the bubble stays in the center, keep the tightness of the three screws in uniform.

16.3 Inclination of Reticle

Inspection

1. Sight object A through the telescope and lock the horizontal and vertical clamp screws.
2. Move object A to the edge of the field of view with the vertical tangent screw (point A')
3. No adjustment is necessary if object A moves along the vertical line of the reticle and point A' still in the vertical line.

As illustrated, A' offsets from the center and the cross hair tilts, then need to adjust the reticle.

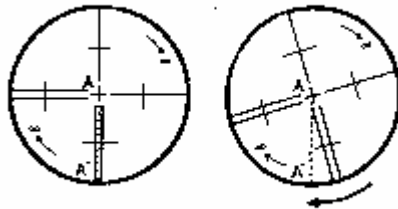

Adjustment

1. If the object A does not move along the vertical line, first remove the eyepiece cover to expose the four reticle adjusting screws.
2. Loosen the four reticle adjusting screws uniformly with an adjusting pin. Rotate the reticle around the sight line and align the vertical line of the reticle with point A'.
3. Tighten the reticle adjusting screws uniformly, Repeat the inspection and adjustment to see if the adjustment is correct.
4. Replace the eyepiece cover.

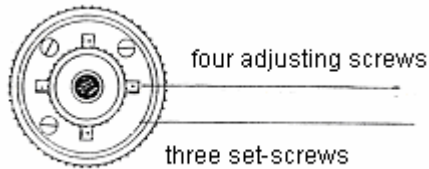

16.4 Perpendicularity of line of sight to Horizontal Axis (2c)

Inspection

1. Set object A at a far distance the same height as the instrument, then level and center the instrument and turn on the power (horizontal angle $L=10^{\circ}13' 10''$).
2. Sight object A in left position and read the horizontal angle value (horizontal angle $R=190^{\circ}13' 40''$).
3. Loosen the vertical and horizontal clamp screws and rotate the telescope. Sight object A in right position and read the horizontal angle value.
4. $2 C=L-R\pm 180^{\circ}=-30'' \geq \pm 2 0''$, adjustment is necessary.

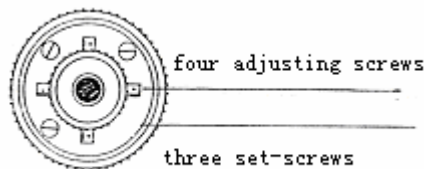

Adjustment

1. Use the tangent screw to adjust the horizontal angle reading,
2. Take off the cover of the reticle between the eyepiece and focusing screw. Adjust the two adjusting screws by loosening one and tightening the other. Move the reticle to sight object A exactly.
3. Repeat inspection and adjustment until $| 2 C | < 2 0''$.
4. Replace the cover of reticle.

16.5 Vertical Index Difference Compensation

Inspection

1. Mount and level the instrument and make the telescope parallel with the line connecting the center of the instrument to any one of the screws. Lock the horizontal clamp screw.

2. After turning on the power, zero the vertical index. Lock the vertical clamp screw and the instrument should display the vertical angle value.

3. Rotate the vertical clamp screw slowly in either direction about 10mm in circumference, and the error message “b” will appear. The vertical axis has increased to more than 3´ at this time and exceed the designated compensation range.

Rotate the above screw to its original position, and the instrument display screen will show the vertical angle again, meaning that the vertical index difference compensation function is working.

Adjustment

If the compensation function is not working, send the instrument back to the factory for repair.

16.6 Adjustment of Vertical Index Difference (i angle) and Vertical

Angle 0 Datum

Inspect the item after finishing after finishing the inspection and adjustment of Item 13.3 and 13.5.

Inspection

1. Power on after leveling the instrument. Sight object A in left position and read the Vertical angle value L.

2. Rotate the telescope. Sight object B in right position and read the Vertical angle value R.

3. If the vertical angle is 0° in zenith, $i = (L + R - 360°) / 2$

If the vertical angle is 0° in horizon. $i = (L + R - 180°) / 2$ or $(L + R - 540°) / 2$.

4. If $|i| \geq 10''$ shall set the Vertical Angle 0 Datum again.

Adjustment

1. After leveling the instrument, turn on the instrument while pressing **F1** key:

ADJUSTMENT MODE
F1: V ANGLE 0 POINT
F2: INST. CONSTANT

2. In left position rotate the telescope. Precisely sight the any target A in same height with the instrument until the vertical angle displayed. Press **F4** key:

```

V0 ADJUSTMENT
<STEP-1> FRONT
V:  88 ° 09' 30"
                                ENTER

```

3. Rotate the telescope, and sight the same target A precisely in the right position. Press **F4** key. Setting is finished and the instrument return to the previous Angle Measurement

Mode:

```

V0 ADJUSTMENT
<STEP-2> REVERSE
V:  279 ° 0' 0"
                                ENTER
<SET!>

```

4. Repeat the inspection sets to measure the Index Difference (i angle). If the Index Difference cannot meet the requirement, you should check whether the three steps of the Adjustment are right, the sight is right and etc. Then set again according to the requirement.

5. If Index Difference is still meet the requirement after the repeated operation, the instrument should be returned to factory for inspection and repair.

- The vertical angles shown in the Vertical Angle 0 Datum are only for reference.

16.7 Optical Plummet

Inspection

1. Set the instrument on the tripod and place a piece of white paper with two perpendicular lines, then intersect drawn on it directly under the instrument.

2. Adjust the focus of the optical plummet and move the paper so that the intersection point of the lines on the paper comes to the center of the field of view.

3. Adjust the leveling screws so that the center mark of the optical plummet coincides with the intersection point of the cross on the paper.

4. Rotate the instrument around the vertical axis and at every 90° observe whether the center mark position coincides with the intersection point of the cross.

5. If the center mark always coincides with intersection point, no adjustment is necessary. Otherwise, the following adjustment is necessary.

Adjustment

1. Take off the protective cover between the optical plummet eyepiece and focusing knob.
2. Fix the paper. Rotate the instrument and mark the point of fall of the center of optical plummet on the paper at every 90°. As illustrated: Point A, B, C, D.
3. Draw lines that attach AC and BD and mark the intersection point of the two lines as O.
4. Adjust the four adjusting screws of the optical plummet with an adjusting pin until the center mark coincides with Point O.
5. Repeat the inspection and adjusting steps to be sure the adjustment is correct.
6. Replace the protective cover.

16.8 Instrument Constant (K)

Instrument constant has been checked and adjusted in the factor, $K=0$. It changes seldom and it is suggested to check one or two times every year. The inspection should be made on the base line, also can be made according to the following method.

Inspection

1. Mount and level the instrument on Point A in a plain place. Use the vertical hair to mark Point B and Point C on the same line with the distance of 50m on the same line, and set the reflector accurately.
2. After setting temperature and air pressure in the instrument, measure the Horizontal Distance of AB and AC accurately.
3. Set the instrument on Point B and center it accurately, measure the Horizontal Distance of BC accurately.
4. Then you can get the Instrument Constant:

$$K = AC - (AB + BC)$$

K should be closed to 0, If $|K| > 5 \text{ mm}$, the instrument should be strictly inspected in the standard baseline site, and adjusted according to the inspection value.

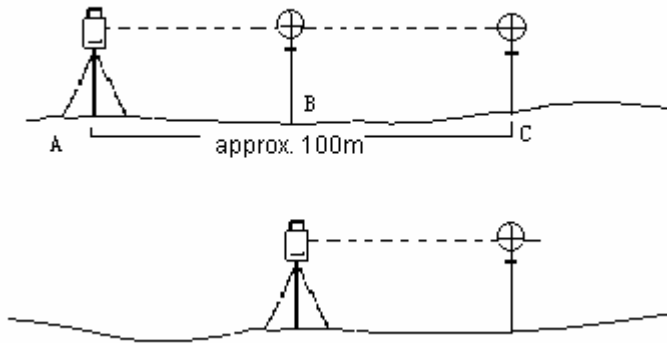

Adjustment

If strict inspection approves that the Instrument Constant K has changed and is not closed to 0. If the operator wants to adjust, should set Stadia Constant according the Constant K (Power On pressing [F1]).

- Set the direction by using the Vertical Hiar to make Point A,B,C on the same line strictly. On Point there must be fixed and clear centering mark.

- Whether the prism center of Point B coincide with the Instrument Center is the B is the important tache to inspect the accuracy. So on Point B Tripod or tribrach compatible should be used. That will decrease the difference.

16.9 Parallel between Line of Sight and Emitting Photoelectric Axis

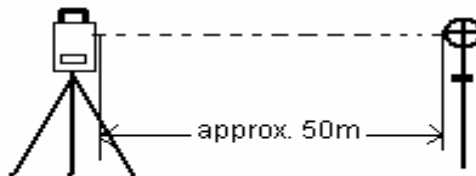

Inspection

1. Set the reflector 50m from the instrument.
2. Sight the center of the reflector prism with reticle.
3. Power on and enter Distance Measurement Mode. Press [MEAS] to measure.

Rotate the Horizontal Tangent Screw and Vertical Tangent Screw, to do electric collimation and make the light route of EDM unblocked. In the bight zone find the center of emitting photoelectric axis.

4. Check whether the center of reticle coincides with the center of emitting photoelectric axis. If so, the instrument is up to grade.

Adjustment

If there is great difference between the center of reticle and the center of emitting photoelectric axis, the instrument need repairing.

16.10 Tribrach Leveling Screw

If the leveling screw becomes flexible, adjust the two adjusting screw in the leveling screw to tighten the screw appropriately.

16.11 Related Parts for Reflector

1. The Tribrach and Adapter for Reflector

The plate vial and optical plummet in the adapter and tribrach should be checked, refer to Chapter 13.1 and 13.7.

2. Perpendicularity of the prism pole

As illustrated, mark '+' on Point C, place the tine of the prism pole on the Point C and do not move during the inspection. Place the two feet tine of Bipod on Point E and F on the cross lines. Adjust the two legs to make the bubble on the prism pole centered.

Set and level the instrument on Point A near the cross. Sight tine of Point C with the center of reticle, and fix the Horizontal Clamp Screw. Rotate the telescope upward to make D near the horizontal hair. Flex the prism pole Leg e to make the D in the center of reticle. Then both Point C and D are on the central line of reticle.

Set the instrument on Point B on another cross lines. With the same way flexing the Leg f to make Point C and D are on the central line of reticle.

Through the inspection by the instrument on Point A and B, Prism pole has been perpendicular. If then the bubble offset from the center, adjust the three screws under circularial to make the bubble centered, refer to Chapter 13.2 .

Check and adjust again until the bubble is in the center of the vial from both directions.

17. SPECIFICATION

Distance measurement :(see the laser)

Types :	red laser
Carrier wave:	0.670um
Measurement system	Basic frequency 60MHZ
EDM type:	same axis
Minimum display :	1 mm
Laser facula :	7×14mm/20m (only reflectorless mode) 10×20mm/50m

Accuracy : with the cooperation mode

Measurement mode	Accuracy standard deviation	Measurement time
Prism : fine	3mm+2ppm	<1.8S
Prism : track	5mm+2ppm	<1.4S
IR reflector	5mm+2ppm	<1.2S

Accuracy: reflectorless

Measurement mode	Accuracy standard deviation	Measurement time
Reflectorless : fine	5+2ppm	<1.2S
Reflectorless: Track	10+2ppm	<0.8S

The object which with signal gap, consuming flicker and move will be affect the accuracy, it will affect the accuracy. when measure the glass,liquid plane ect.

Measurement Distance with the cooperation mode

Atmospare condition	Standard Prism	reflector
5 km	1000m	300m
20km	3000m	800m

Measurement Distance with the reflectorless

Atmospare condition	Reflectorless (white) *	Reflectorless grey degree0.18
Object flicker under the sunshine	80m	5m
Object under the cloudy day	120m	70m

* scale the echo light intension under the korda grey degree standard

Display	Max: 999999.999m Min: 1 m m
Unit	m / f t Selectable
Accuracy	$\pm (2 \text{ m m} + 2 \text{ p p m} \cdot D)$
Measuring time	Fine single shot: 3S Tracking: 1S
Average measuring times	The average value of 2 ~255 times
Meteorologic Correction	Manual input, Auto correction

Telescope

Image	Erect
Magnification	3 0 ×
Effective aperture	4 5 m m (EDM 5 0 m m)
Resolving power	4 "
Field of view	1 ° 3 0 '
Minimum focus	1 m
Stadia ratio	1 0 0
Sight distance precision	$\leq 0 . 4 \% D$
Tube length	154m m

Angle Measurement

Measuring method	Photoelectric detection by incremental encoder
Dia of circle (vertical, horizontal)	79m m
Minimum reading	1 " / 5 " Selectable
Detection method	Horizontal: Dual Vertical : Dual
Measuring unit	360° / 400gon / 6400mil Selectable
Vertical angle 0 °	Zenith 0 ° / Horizontal 0 ° Selectable
Accuracy	NTS-352: 2 " NTS-355: 5 "

Vial

Plate vial	30" / 2m m
Circular vial	10' / 2m m

Vertical Compensator

System	Liquid-electric detection/plate vial
Compensation range	$\pm 3 '$
Resolving power	1 "

Optical Plummet

Image	Erect
Magnification	3×
Focusing range	0.5 m ~ ∞
Field of view	5°

Display

Type	LCD, Four lines, digital
Data Communication	

Port

R S - 2 3 2 C

On-board Battery

Power resource	Rechargeable Ni-H battery
Voltage	DC 6 V
Continuous operation time	NB-20 A 7hrs

Operation Environment

Operating temperature	-20° ~ +45°C
-----------------------	--------------

Size & weight

Dimension	160×150×330mm
Weight	5.2 kg

18. ERROR DISPLAYS

Error information

Error code	Description	Countermeasures
CALC ERROR	Calculation is impossible because of error data input.	Enter correct data.
DELETE ERROR	When deleting coordinate data, it can be done successfully.	Confirm the data and delete again.
FILE EXISTS	The same file name exists.	Use another file name.
FULL FILES	When making a file, 30 files already exist.	If necessary, send or delete files.
FAILED INTIALIZE	Initializing cannot be done successfully.	Confirm initializing data and try to initialize again.
LIMIT OVER	Limit of input data exceeds	Input again
MEMORY ERROR	Any abnormality occurs with internal memory.	Initialize the internal memory.
MEMORY POOR	Short of capacity of the internal memory	Download data from internal memory to PC.
MODE ERROR	Any abnormality occurs with measuring controlling.	
NO DATA	The data is not found in the search mode.	Confirm the data and search again.
NO FILE	There is no file in internal memory.	If necessary, make files.
FILE NOT SELECTED	When using a file, no file is selected.	Confirm the file and select a file.
DISTANCE TOO SHORT	When in point to line measurement, the horizontal distance between first point and second point is with 1m.	The horizontal distance between first point and the second point must be more than 1m.
PT#EXIST	Same new point name is already memorized in the memory.	Confirm the new point name and input again.
PT#DOES NOT EXIST	You enter incorrect name, or PT# does not exist in the internal memory.	Enter the correct name or enter point in the internal memory.

TILT OVER	Instrument tilt over more than 3 minute.	Leveling the instrument properly.
ERROR 01-08	Angle measurement system abnormal	If the error code appears continuously, the instrument needs repair.

If error still persists after attempting to clear them, please contact us.

19. ACCESSORIES

Carrying Case	1 pc
Main Body	1 pc
On-board Battery	1 pc
Backup Battery	1 pc
Charger	1 pc
Plummet	1 pc
Correction Pin	2 pcs
Fur Brush	1 pc
Screwdriver	1 pc
Hexagon Wrench	2 pcs
Cloth	1 pc
Dryer	1 pc
Operation Manual	1 pc