

Buy Now at New England Laser & Transit
Click to Purchase

AGL

GradeLight 2700

Pipe Laser

Owner's Manual

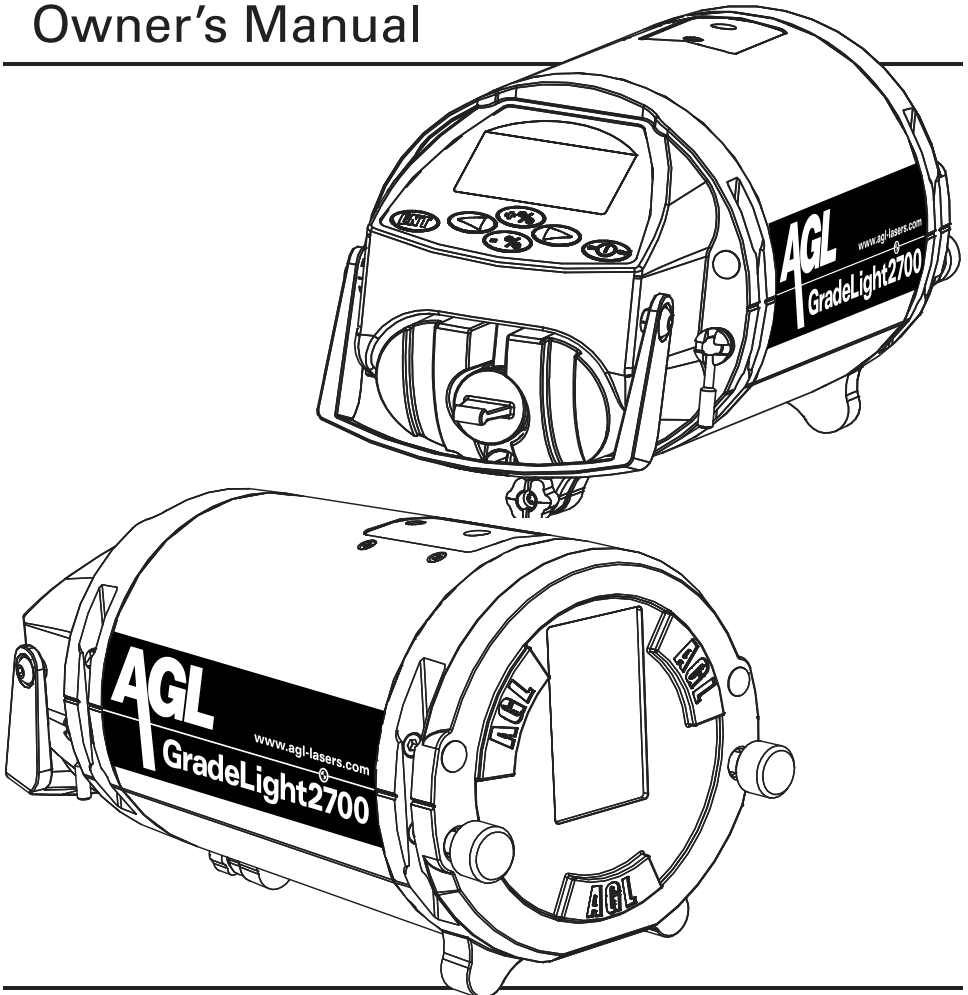

AGL Construction Lasers & Machine Control Systems

2202 Redmond Rd., Jacksonville, AR 72076

sales@agl-lasers.com www.agl-lasers.com

Toll Free: 800.643.9696 Phone: 501.982.4433 Fax: 501.982.0880

CONTENTS

General Information	1-3
Specifications	1
Laser Overview	2-3
Power	4
Charging	4
Removing the Battery Pack and Using Alkaline Batteries	4
Operation	5-9
Pipe Laying Overview	5
Laser Start-up	5
Entering Grade	6
Automatic Reset to Zero Grade	6
Remote Control and Line Adjustment (Azimuth)	7
Replacing Batteries in Remote	8
Adjustable Leg Set	8
Using the Target	9
Basic Set-up and Operation	9
Applications	10-16
Elevation Transfer	10
Using an Automatic Level	10
Using the Special Transit and Rod Group	10
Alignment Methods	11
Manhole Mount with Transit	11
Special Transit with Rod Group	12
Stringline Method	12
Plumb Bob Method	12
Set-up Methods	13
Height Adjustable Legs	13
Manhole Base Set-up	13
In-the-pipe Set-up	13
Invert Set-up	14
Open Cut Set-up	14
Trivet	15
Manhole Base Set-up	15
Rod and Crossbrace System	15
Manhole Set-up	15
Above Ground Set-up	16
Menu Options	17-18
Information Available (including software version)	17
Entering the Set-up Menu	17
Changing the Service Interval	18
Deleting CHECK CAL Reminder	18
Using Your Company Information for the Start-up Screen	18
Troubleshooting	19-20
Display Screen Explanations	19
Using a Blower to Eliminate Refraction	20
Optional Equipment	20
Checking and Calibration	21-23
Safety, Care, and Handling	24
Warranty	25

Important:

The operator of the Gradelight is expected to follow all operating instructions, periodically check the accuracy of the unit, and make checks on control as the work progresses. The manufacturer and its distributors assume no responsibility for improperly controlled work.

GENERAL INFORMATION

The GradeLight pipe laser provides alignment and grade for installation of gravity flow sanitary and storm sewer pipelines, as well as for pipe jacking and tunneling.

The GradeLight includes:

- Infrared remote control
- Adjustable leg set for multiple pipe sizes
- Rechargeable Li-ion battery pack and spare alkaline battery compartment.

Other features include a wide automatic self-leveling range, short length to fit tight inverts, and adjustable target with magnetic base (included in designated packages).

Specifications

GradeLight

Self-Leveling Range	+45% to -15%
Grade Range	+40% to -10%
Grade Entry	Rolling counter or digit select
Grade Display	0.001%
Azimuth Range	Total range: 20 ft. at 100 ft. (6m at 30m)
Accuracy	± 1/16" at 100 ft. (± 5mm at 100m; ± 10 arc sec.; ± .005%)
Cross Axis Leveling	Manual
Beam Type/Output	Visible laser diode, 635nm, < 5mW, Class 3R
Environmental	IP68; nitrogen purged
Power Supply	1) Rechargeable lithium ion battery pack 2) 110/230V AC converter (charge and run simultaneously) 3) Spare battery compartment for 4 D-cell alkaline batteries 4) Optional 12V power cord
Battery Life at 32° F / 0° C	40 hrs. Li-ion battery; 50 hrs. alkaline
Charging Time	5 hrs. maximum
Mounting	5/8 x 11 (female mounting thread)
Operating Temperature	-4° to 122° F (-20° to +50° C)
Storage Temperature	-40° to 140° F (-40° to +60° C)
Dimensions	Diameter: 5.5" (140mm) / Length: <10.5" (265mm)
Weight	7.6 lbs (3.5 kg) with alkaline battery
Warranty	1 year (2 and 3 Year Optional Warranties Available)

Remote

Operating Range	600' (190m) front (through the pipe); 25' (7.6m) from rear
Batteries	3 AA alkaline
Battery Life	2,000 hrs (1 year)
Dimensions	4.7" x 2.35" x 1.2" (119 x 60 x 30mm)

Laser Overview

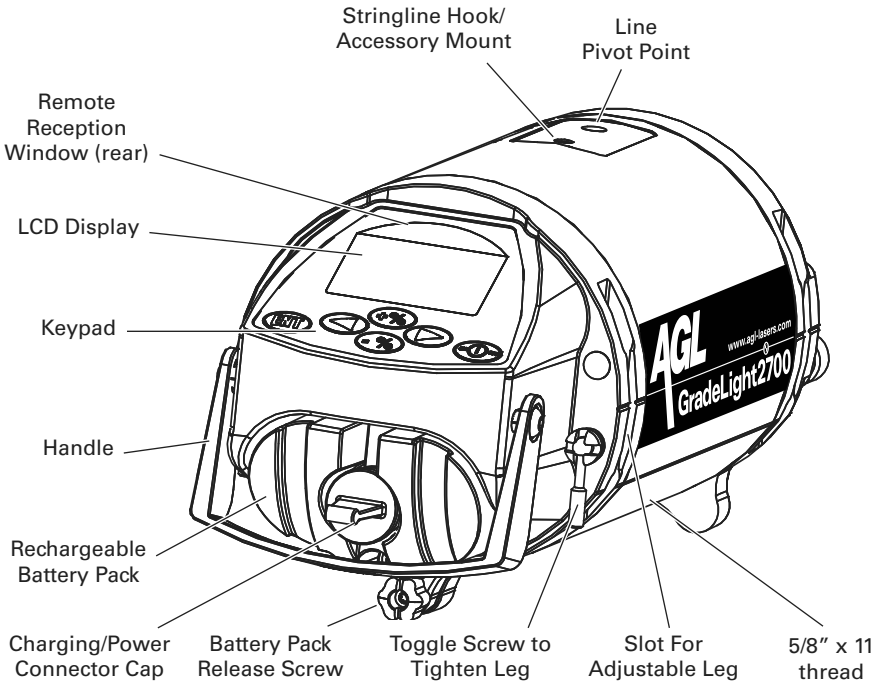

Leg Reference Lines
Align To Marks on Legs

Beam Output
& Remote Reception
Window

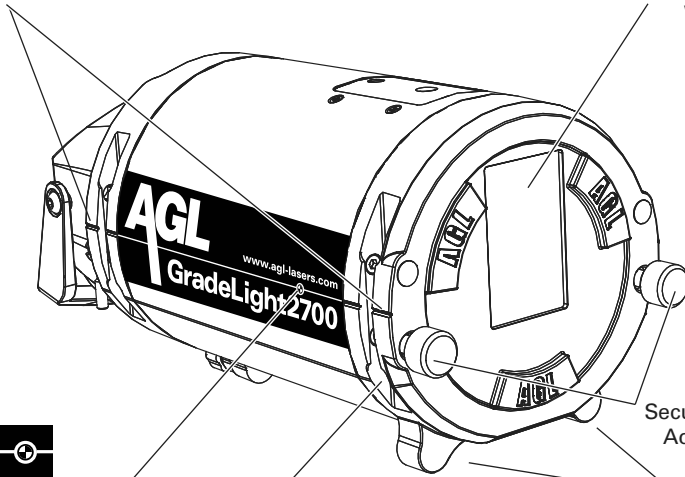

Beam's Horizontal
Centerline







Adjustable
Leg Slot

Securing Knobs For
Adjustable Legs

Feet For 6"
(150mm) Pipe

Keypad and LCD Overview

Keypad Functions

	Power On/Off
	Enter digit select mode for grade Enter user settings menu
 	Set azimuth line (left & right) Change digit positions when setting grade
 	Set grade as rolling counter or digit select

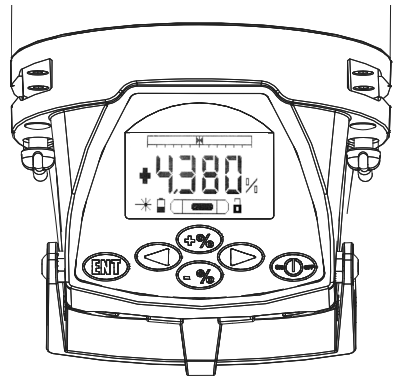

LCD Indications

Line Adjustment Range Indicator

Shows beam position relative to line adjustment range.

Grade Entered

Self-Leveling Status

Battery Status

Cross Axis Level Position

Lock Status of Laser and Remote Keypad

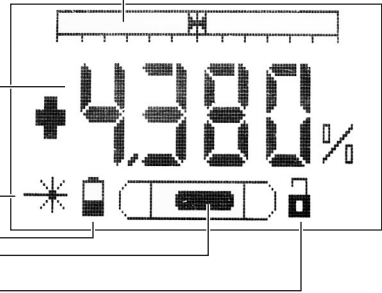

The display is backlit for 30 seconds when any button is pressed on the laser or remote.

Safety Labels

The GradeLight is a Class 3R laser, manufactured to comply with the international rules of safety IEC 60825-1, 2001. Although the power of the emission of the beam is less than 5mW in Class 3R, the following cautions are recommended:





- Do not stare directly at the beam



- Do not set up the laser at eye level



AGL		2202 REDMOND RD., P.O. BOX 189 JACKSONVILLE, AR 72076	CLASS 3R LASER PRODUCT WAVE LENGTH 630-680 nm MAX OUTPUT: 5 mW LASER LIGHT: AVOID DIRECT EYE EXPOSURE CONFORMS TO IEC 6082501; 2001 COMPLIES WITH 21CFR 1040.10 and 1040.11 EXCEPT FOR DEVIATIONS PURSUANT TO LASER NOTICE No. 50, DATED JULY 26, 2001
MODEL	SERIAL NUMBER		
P/N	Made in U.S.A.		

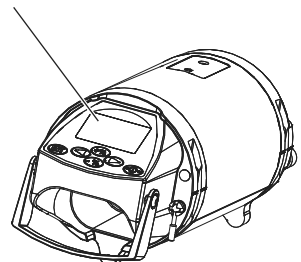
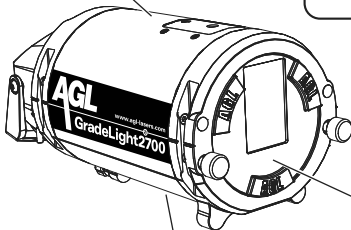

CAUTION:
CLASS 3R LASER LIGHT WHEN OPEN
AVOID DIRECT EYE EXPOSURE

AVOID EXPOSURE: LASER LIGHT
IS EMITTED FROM THIS APERTURE

POWER

The GradeLight can be powered from the Li-ion rechargeable battery or the alkaline battery pack. It can also be used while charging -- from AC using the included converter, or from 12VDC using the optional power cable.

Charging

Charge before first use and when the battery symbol indicates low. The Li-ion battery can be charged in the unit, or removed and charged separately. This allows you to use alkaline batteries in the spare battery compartment on the job site while the battery is being charged elsewhere.

The charging circuit is in the battery pack; the converter with cord allows charging from AC. Maximum charging time is 5 hours; a microcontroller prevents overcharging.

To Charge the Battery:

- 1) Connect the converter to the charging/power connector on the battery pack.
- 2) Select the correct power plug adapter for your country and attach to the converter. Then plug the converter into a 110V or 220V AC outlet. A green LED indicates power; it is not a charging indicator.
- 3) Always place the cap back onto the charging connector to protect from dirt.

The laser can be used while charging, but the charging time may increase (up to 9 hours).



- Do not charge in wet environments.



- Do not use the charger with a generator.

Connector for charging or for optional 12VDC power cord

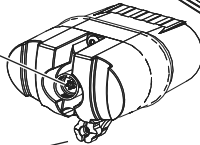

Battery Pack Release Screw

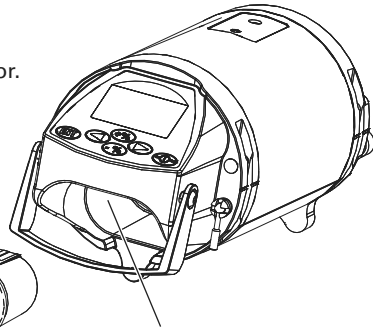

Purge screw under black decal inside battery compartment

DO NOT OPEN!

If this screw is removed, the moisture-free nitrogen purge of the unit will be lost.

Removing the Battery Pack and Using Alkaline Batteries

The rechargeable battery pack can be replaced with the alkaline battery compartment or another Li-ion pack. Turn off the laser. Turn the release screw under the battery pack to remove it.

If using the alkaline battery compartment, insert 4 "D" cells, noting the polarity indications on the outside of the case.

NOTE: If the laser has been stored for a while, hold the ON button for at least 3 seconds when starting the unit.

OPERATION

Pipe Laying Overview

The three basic steps to successfully set up the GradeLight for laying pipe are:

- A. Dialing in the correct grade.
- B. Transferring the elevation to position the laser at the correct height.
- C. Aligning the laser beam to the forward manhole.







Before Starting

Attach the necessary mounting accessories, such as the handle/rod mount, trivet, legs, etc. to the unit. Power-up the unit and adjust the line control to the center of its range.

At the beginning of a pipe laying job, consider the following tips for improved performance:

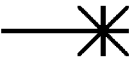
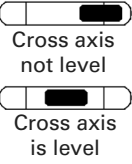
- The GradeLight can be used to check the hubs prior to actually starting the work. This is an opportunity to catch potential errors before using the hubs as a reference to lay pipe.
- Place grade rod or marker at the forward manhole for a place to align to.
- When the last joint of pipe has been laid approaching a manhole, bring the GradeLight forward so that as soon as the manhole is in place, you can set up again without delay.

Laser Start-up





	<p>Press On/Off button to power-up the laser. Check the following indications on the LCD:</p>
	<p>The start-up screen shows AGL.</p>
<p>BATTERY CHECK</p> 	<p>The battery capacity is displayed. Charge when there is one bar left.</p>
	<p>The laser automatically self-levels, and returns to the same grade and line settings as last used. If the LCD laser beam symbol is flashing, it's still leveling. When the symbol is lit solid, the laser has leveled and is ready for use. Likewise, the beam emitted from the unit flashes until it has leveled.</p>
 <p>Cross axis not level</p> <p>Cross axis is level</p>	<p>Check the electronic cross axis vial. If it's out-of-level, rotate the laser slightly to the left or right to level the cross axis. The bubble should be between the lines on the vial.</p>
 <p>Center beam with: Laser keypad</p>  <p>or remote:</p> 	<p>Before each setup, center the beam using the laser keypad (press both arrows simultaneously for 2 seconds) or the remote (press CL button).</p>

Entering a Grade

The grade range is from +40% to -10%. Grade can be set in increments as small as .001% using the digit select or rolling counter entry method.

The display lights when entering grade. The LCD is color coded to match the grade entry button: green for positive grade and red for negative grade.

Digit Select Grade Entry

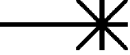
	Press ENT. The first digit flashes.
	Select positive or negative grade. The first digit will continue to flash. To the left of the decimal is a whole unit of per cent grade; to the right of the decimal are tenths, hundredths, and thousandths.
 Increase Decrease	Change the value of the first digit with the grade buttons (+ to increase, - to decrease). For large changes hold the button.
	Use the azimuth left or right arrows to move through the digits and to choose the next digit to be changed. The digit you're working with will flash like a computer cursor. Use the + and - buttons again to change the value.
	After the desired digits have been chosen, press ENT to save, and begin the grade that's been set.
	The LCD beam symbol flashes until the grade setting is reached.

Rolling Counter Grade Entry

For a positive grade, hold the + button for 15 seconds or more. After you release, it will automatically increase in grade until you push either the + or - button again to stop.

For a negative grade, hold the - button as described above.

Automatic Reset to Zero Grade

Press both the + and - buttons simultaneously to automatically set the grade back to 0.000%.



Remote Control Overview

The remote is used primarily to move the beam left or right, within the azimuth range, and to put the laser in standby or locked modes. Since it's an infrared line-of-sight device, there should be no obstructions between it and the laser. It can be pointed at either the front side (through the pipe) or the back side of the laser.

Infrared output:
aim at capture
window of laser



LED flashes when any
button is pressed.
-- Green: normal
-- Red: low remote battery

Compartment for
3 AA batteries
(back side)

Remote Keypad Functions

	Standby Mode <ul style="list-style-type: none">• Press and hold 2 seconds. This puts laser in standby mode to save battery life during breaks. LCD on laser will show sleep symbol.• Press again to return to normal operation. All settings are retained.
	Reset Line to Center <p>Hold 2 seconds, and laser beam automatically moves back to center azimuth position.</p>
	Line Adjustment (left and right azimuth control) When using remote from the target side, beam moves in the direction of the arrows. If using remote from laser keypad side, beam moves in the opposite direction.
	Activates Lock Function All buttons on the remote and laser are blocked, preventing unintentional changes when the laser is in use. LCD on laser shows a lock symbol. To deactivate: Press the lock button again.
	LED for Line Pivot Point Press to turn on LED on top of laser, which is used for alignment outside of the manhole. Automatic shut-off after 1 minute.

Line Adjustment

The laser beam can be aligned to the target using the left and right line adjustment. The azimuth indicator on the LCD shows the beam position in the adjustment range. Before each setup, center the beam to allow maximum adjustment in each direction. The total range of movement is 20' at 100' (6m at 30m).

To Move the Beam

Use arrows on the laser keypad or remote. Movement will start slow and speed up as long as the button is pressed.

To Automatically Center the Beam

On laser keypad, press simultaneously ◀ & ▶

On remote, press 

Replacing the Batteries of the Remote Control

The LED on the remote will flash red when the batteries are low. To change the batteries:

1. Open the housing by removing the 6 screws.
2. Take the back case off and replace the batteries, matching the polarity indications. Use AA alkaline batteries of the same type; do not mix new and old batteries, as their lifetime will decrease.
3. Before closing, check that the seal is free of dirt, to ensure it remains waterproof.
4. Close the housing and tighten the 6 screws so it's watertight.



Adjustable Leg Set

One leg set covers multiple pipe sizes. The adjustable “slide leg system” allows the user to set centerline in 8”, 10” and 12” pipe (200, 250, and 300mm with the metric leg set). The legs can also be adjusted to non-standard heights.

The three-leg design provides stability when setting up on uneven, rough surfaces.



To attach legs:

1. Use curved centerline leg at rear (keypad end) and two side legs at front.
2. Slide each leg into the slot on the housing.
3. Match the red reference marks on the housing to red mark on leg. There are 3 reference marks: 8”, 10”, and 12” (200, 250, and 300mm).
4. Tighten front legs with thumb screws, and single leg with toggle screw.

Note: The legs will then be aligned for use in a pipe’s curved surface, where the two side legs need to be shorter than the center leg. If you are setting up on a flat surface, adjust the legs differently to level the unit.

For 6” pipe (150mm), use the unit’s built-in feet. A long leg set is available as an optional accessory for 15” to 24” pipe (with a metric leg set for 375 to 600mm pipe).

Using the Target

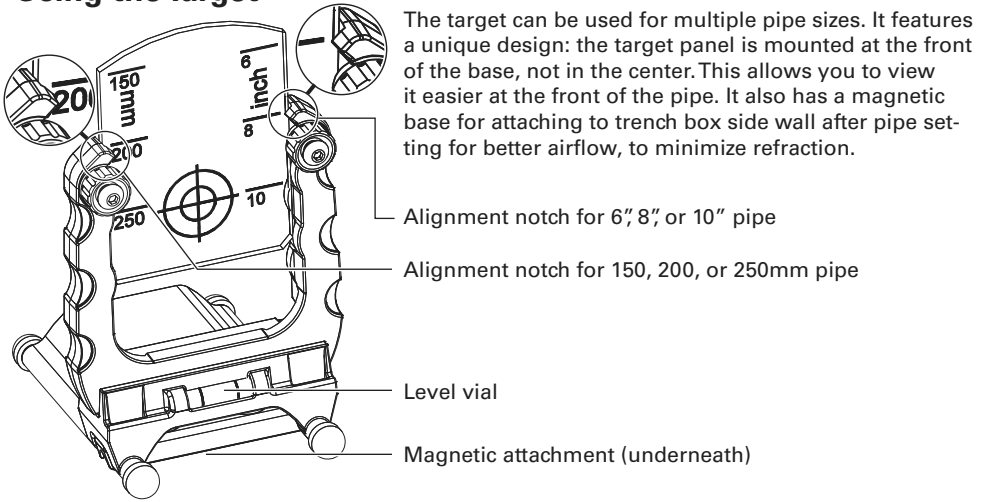

The target can be used for multiple pipe sizes. It features a unique design: the target panel is mounted at the front of the base, not in the center. This allows you to view it easier at the front of the pipe. It also has a magnetic base for attaching to trench box side wall after pipe setting for better airflow, to minimize refraction.

Alignment notch for 6", 8", or 10" pipe

Alignment notch for 150, 200, or 250mm pipe

Level vial

Magnetic attachment (underneath)

Basic Set-up And Operation

The steps noted below are illustrated in previous sections. See next section for specific applications.

1. Attach any mounting accessories to the unit, such as the legs, trivet, handle/rod mount, etc. Place it in the manhole or pipe at the proper offset and elevation.
2. Power-up the laser. Swivel it left or right so that the cross axis is level. Check the vial on the LCD (see p. 3). Set the desired grade.
3. Adjust the target plate to the correct pipe diameter. Place the target in the opposite end of the pipe and level it using the vial.
4. Adjust line to the center of its range with the remote by pressing the centerline button or by pressing both line adjust buttons simultaneously. Use the remote to align the beam to the target.
5. Lift pipe up or down until beam is in the middle of the target bull's-eye; the pipe is then on line and at the desired slope.

APPLICATIONS

Transfer of Elevation

Using an Automatic Level

1. Mount the level on a tripod outside the manhole or open cut. Adjust it to level and point at the manhole hub. Take a reading from a rod held at the hub. This reading is sometimes called the "back-sight" reading. (Figure A)
2. Now take a rod reading at the manhole center. If a manhole is in place, read the elevation of the base. In an open cut it is necessary to place an object in the cut which can be used as a reference. A brick, stone, or board placed at manhole center will work for marking a reference elevation, and as a starting point for the placement of the laser or the trivet.

Using the Special Transit and Rod Group

This is an ideal method to use when the offset hub is too far from the manhole center to transfer elevation with a batter-board or other means. The Special Transit is set up using the Rod and Crossbrace System. (Figure B)

1. Mount the Special Transit on the calibrated rod and point it to the manhole hub. The top edge of the transit mounting bracket is the elevation reference and is the same as the horizontal crosshair (centerline) of the transit.
2. Level the transit using the adjust knob and the level vial. Use the forward marker knob to adjust the transit so that it is pointed exactly to an engineer's rule or calibrated rod section held at the manhole hub.
3. After reading the engineer's rule or calibrated rod, measure down from the top edge of the transit mounting bracket (transit centerline) to the correct invert elevation.

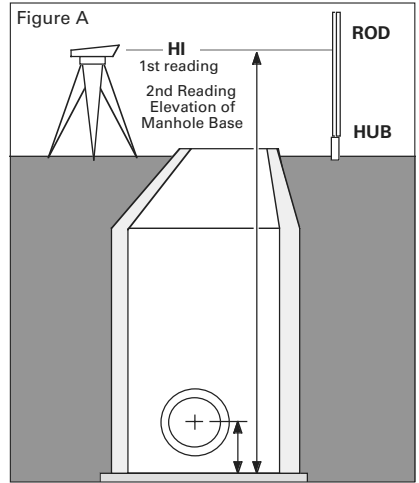

Alignment Methods

After the laser is set up at the correct elevation and the correct grade is entered, the last step is to align the beam to the forward manhole using one of these methods:

- 1) Manhole Mount with Transit
- 2) Special Transit and Rod Group
- 3) Stringline
- 4) Plumb Bob

Manhole Transit Method

This method can be used with the Special Transit or any standard transit (ideally one that has a back sight – flop – capability). Use the Manhole Transit Clamp system to support the transit. The laser is set up in the manhole using leg sets, or the trivet.

1. Secure the Clamp Body and Mast (Figure C). Position the clamp (1) over the top edge of the manhole so the mast (2) is plumb enough to easily level the transit when mounted. Tighten the clamp screw (3), until the clamp points are firmly embedded in the sides of the manhole. The mast can be further adjusted to plumb using the lever (4) locking the mast pivot.

Secure the Arm - Slide the arm clamp support (5) and the arm clamp (6) over the mast and secure. Insert the arm (7) into the clamp. The clamp allows complete flexibility to raise, extend, and position the arm so the transit mount (8) is over the manhole center. The transit mount is a 5/8 x 11 male attachment for mounting a standard transit. The AGL Special Transit is mounted, using an adapter assembly.

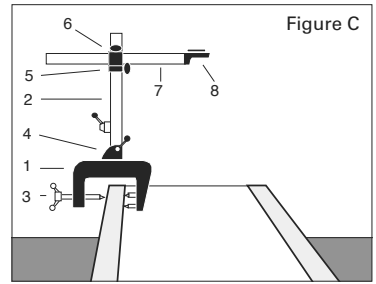

Figure C

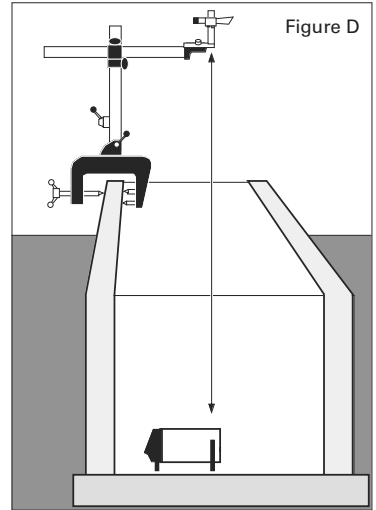

Figure D

Aligning the beam with the AGL Special Transit

2. Mount the Special Transit and adapter to the mount at the end of the arm. Adjust the arm so the transit is roughly over pipe centerline and in line with the laser (Figure D). Adjust the vertical crosshair exactly to the forward manhole marker using the forward marker knob.
3. Align Transit to Laser - Tilt the transit down and sight the line pivot green LED. On the transit, use the laser centerline knob to adjust the vertical crosshair until aligned exactly with the green LED. Repeat steps 2 and 3 until the vertical crosshair is on both the forward manhole marker and the green LED on the unit.
4. Align the Laser Beam to the Transit - Place a target in the ditch approximately 15' (5m) in front of the laser. Looking through the transit at the target, adjust the beam left or right using the alignment buttons on the remote control until exactly centered on the vertical crosshair. You should then be able to swing the transit from the beam, to the green LED, and to the forward manhole marker, with each being aligned to the crosshair (Figure E). Repeat steps 2, 3 and 4 if necessary. When all three are accurately aligned, pipe laying can proceed.

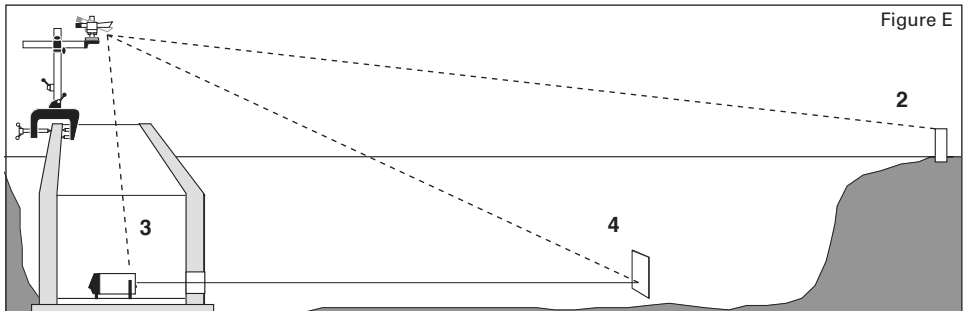

Figure E

Aligning the beam with a standard transit

Align the Transit over the Instrument - Mount the standard transit to the transit mount at the end of the arm. Using a plumb bob, adjust the arm so the transit is directly over the centerline of pipe. Level the transit. Position the laser so the line pivot LED is exactly under the plumb point.

Align the Transit to Forward Manhole - Pivot the transit until the vertical crosshair splits the forward manhole marker.

Align to the Beam using step 4 above.

Special Transit Method

This method uses the Rod and Crossbrace system. The laser is mounted with the Handle/Rod Mount (Fig F).

1. Mount the Special Transit - With the rod plumbed, and laser leveled, mount the Special Transit on the rod. Position the transit where it is possible to see the forward manhole marker, yet as low as possible on the rod. Secure the rod mounting bracket with the secure knob.
2. Align Transit to Forward Manhole Marker - Use the forward marker knob to adjust the vertical crosshair until it is aligned with the forward manhole marker.
3. Align Transit to Laser - Tilt the transit down and sight on the green LED. On the transit, use the laser centerline knob to adjust the vertical crosshair until it is exactly aligned with the green LED on the laser. Repeat steps 2 and 3 until the crosshair is on the forward manhole marker and the green LED.
4. Align the Laser Beam to the Transit - Place a target in the ditch approximately 15' (5m) out in front of the laser. Tilt the transit down to view the target. Adjust the beam left or right using the line adjustment buttons on the remote until the beam is exactly centered on the vertical crosshair.

You should be able to swing the transit from the beam, to the green LED, or forward manhole marker, with each being exactly aligned to the crosshair. Repeat steps 2, 3, and 4 if necessary. When all three are accurately aligned, pipe laying can proceed.

Stringline Method

The stringline provides a quick, easy method of beam alignment. Place a target in the ditch approximately 50' (15m) out from the laser. Attach a string to the eyelet hook, located on top of the GradeLight and keeping it plumb, hold it taut, vertically above the unit (Figure G).

Stand behind the string and visually center it on the forward manhole. Lower your gaze to the target and use the remote control to adjust the beam left or right until exactly centered behind the stringline.

When you can see the stringline centered on the forward manhole marker and on the beam in the ditch, alignment is complete.

Plumb Bob Method

This method of alignment can be used if the cut is not too deep and the wind is relatively calm. The laser must be set up at the correct elevation and exactly on pipe centerline. Place a target in the ditch approximately 50' (15m) out from the laser. Measure over from an offset hub to the pipe center line and drop a plumb bob down to the target.

Mark where the plumb bob strikes the target and adjust the beam left or right until it is centered on the plumb mark.



Figure F

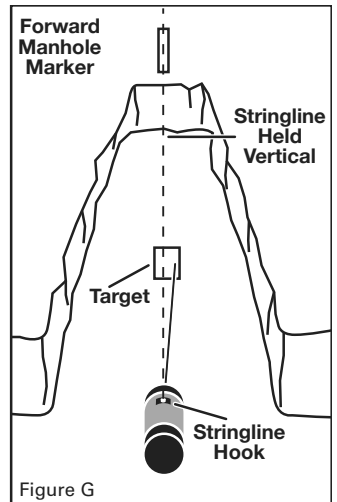

Figure G

Set-up Methods

These instructions describe four ways to set up: height adjustable legs, trivet, rod and crossbrace, or above ground on a tripod.

Height Adjustable Legs

The adjustable legs can be used to set up in a manhole base, pipe, invert, or open cut.

Manhole Base Set-up

1. Prepare laser for use: Attach leg set with centerline leg at front and two side legs at rear. Apply power, center the line adjustment, and enter the desired grade.
2. Transfer elevation from the hub to the manhole base.
3. Set the front (centerline) leg to the desired height: After determining the desired beam height above the manhole base, adjust the front leg so the beam will be projected at that height.
4. Set the unit in place: Position the point of the front leg on pipe centerline, 2" (5 cm) in front of the manhole center, toward the pipe being laid for accurate alignment. (Figure H)
5. Roughly level the instrument by loosening the rear leg knobs and sliding the unit up or down, then tighten.
6. Align laser to the forward manhole (see previous section on "Alignment").
7. Recheck for level and accurate grade setting and proceed to lay pipe.

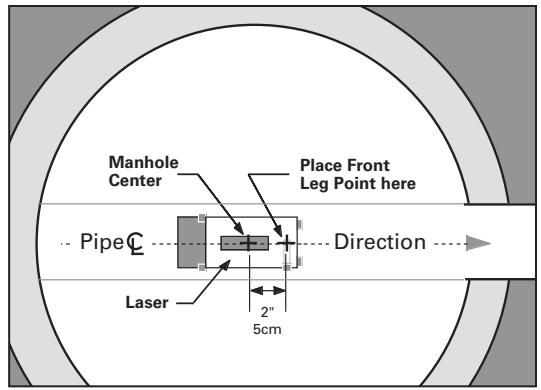

Figure H

In-the-pipe Set-up

When setting up in-the-pipe, be sure the joint of pipe used for the set-up is accurately placed for line and elevation.

Set-up in 6" (150mm) pipe:

1. Remove the handle/rod mount and legs, if attached. Apply power, center the line adjustment, and enter the desired grade.
2. Slide the unit into the pipe. It should rest on the three fixed short leg points of the housing. Rough level the unit in the cross axis direction if necessary, using the lighted cross-axis level vial on the rear control panel.
3. Align the beam to the forward manhole using the remote line control, or the line adjustment buttons on the unit.

Set-up in 8", 10" (200mm, 250mm) and larger pipe:

1. Remove the handle/rod mount if attached. Apply power, center the line adjustment, and enter desired grade.
2. Attach the leg set with two side legs at the front and the centerline leg at the rear. Set all three legs so the appropriate pipe size mark is aligned with the centerline-of-beam mark beside each leg slot.
3. Slide the unit into pipe and rough level in the cross-axis direction using the cross-axis level vial on the control panel.
4. Align the beam to the forward manhole using the remote line control, or the line adjustment buttons on the unit.
5. The beam should be projecting at pipe centerline. Allow the unit to self-level, then lay pipe.

NOTE: If you prefer, you can use the 6" (150mm) for ALL in pipe set-ups as long as you remember to reference the lower offset to the gravel and trench excavation depth. What is important is that the beam elevation from the invert and the target centerline elevation from the invert is the same.

Invert Set-up

Position the legs the same as you would if setting up inside the pipe. Place the laser in the invert and complete the set-up as shown in the Manhole Base Set-up in the previous section.

Open Cut Set-up

When using the height adjustable legs in an open cut, a stable base such as a concrete block, brick, or board must be placed in the cut at the manhole center and marked. This is best done when transferring elevation (see page 10).

Place one of the blocks at manhole center. The front leg will be positioned on this block 2" (5 cm) in front of the center mark for critical high accuracy, or on top of a centerline hub for most applications. Place the other blocks, etc. so that they provide support for the rear legs (Figure I).

Set up the unit for laying pipe as described in Manhole Base Setup in the previous section.

Invert Peg Set-up (Open Cut)

This method is commonly used in open ditches. The cut should be excavated approximately 6" (150mm) below invert elevation. (Figure I)

1. Place a stake at the invert elevation.
2. Prepare the laser for use: apply power, center the line adjust range, and enter the desired grade. Attach the leg set with the centerline leg at the front and two side legs at the rear.
3. Set the front centerline leg for correct pipe size using the marks on the legs.
4. Place the laser in the trench with the single front leg on the stake (peg). Rest the rear legs on blocks, bricks, or the ground.
6. Align the beam to the forward manhole.
7. Recheck for accurate grade settings and a level unit. Proceed to lay pipe.

NOTE: In open cut set-ups the optional long leg set is usually required.

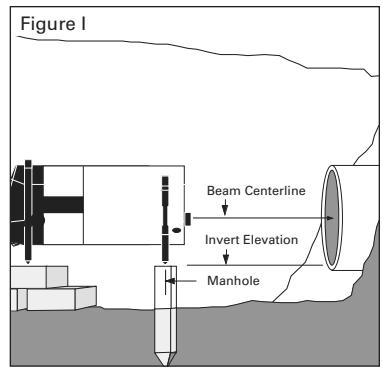

Trivet

Manhole Base Set-up

1. Prepare the laser for use: Attach handle/rod mount, apply power, center the line adjustment, and enter desired grade. Mount the height adjustable rod (center the rod height in its adjustment range) to the trivet. (Figure J)
2. Transfer elevation from the hub to the manhole base.
3. Position the trivet over the manhole center: Place the front leg of the trivet on the centerline-of-pipe, 5" (13 cm) in front of the manhole center mark.
4. Secure the laser to the rod at the approximate elevation where the pipe centerline will be.
5. Allow the unit to self-level.
6. Use the height adjustable rod to precisely adjust the beam elevation. The centerline of beam marks on the side of the unit are also convenient for establishing elevation.
7. Align the beam to the forward manhole. Recheck all the alignment steps to assure accuracy. Check that the unit is level with an accurate grade setting. Proceed to lay pipe.



Rod and Crossbrace System

1. Prepare the laser for use: Attach handle/rod mount, apply power, and center the line adjustment.
2. Mount crossbrace inside the manhole, perpendicular to the centerline of pipe being laid. Use the level vial on the crossbrace to position it level. Holding the two points firmly against the manhole wall, extend and tighten the adjusting screw point against the opposite wall. Tighten until the crossbrace is solid, with the points planted firmly into the concrete.
3. Secure alignment element to the crossbrace using the secure knob. Hang the alignment element on the crossbrace so that the line control and front secure knobs face the forward manhole. Measure manhole width where the crossbrace is mounted and use the center as reference. Place the right edge of the alignment element 2 1/4" (57mm) left of manhole center.
4. Slide the calibrated rod with the point attached through the alignment element, plumb it using a hand level, then tighten the secure knob.

NOTE: Pull up on the crossbrace as you tighten the alignment element, then release after it is tight. This places downward tension on the rod and increases its stability.

5. Establish invert elevation and beam height (see previous section on "Transfer of Elevation - Special Transit Method").
6. Secure the laser to the rod at the correct elevation and allow the unit to self-level.
7. Align beam to the forward manhole (see previous section on "Alignment - Special Transit Method"). Recheck alignment steps to assure accuracy. Check for level unit and accurate grade setting, then proceed to lay pipe.

Above Ground Set-up

1. Prepare laser for use: mount the sighting scope and attach to a 5/8"x11 dome head tripod. Center the line adjustment, and set grade at exactly zero.
2. Measure over from an offset hub and position the tripod directly over the pipe centerline trying to keep the top of the tripod as level as possible. Use a plumb bob if needed. Spread the tripod legs and plant them firmly into the ground to provide a stable base.
3. Allow the laser to self-level.
4. Slightly loosen the tripod securing knob and turn the laser and scope to the rod held at the manhole hub. Tighten the knob, then use the line adjust buttons to align the beam exactly to the rod. Take a reading (sometimes called "back-sight" elevation) at the beam centerline. This measurement plus the "cut" at that hub will be the HI (instrument height) above the invert.

If the grade pole is used on top of the pipe, allow for the height difference when setting up (Figure K). Set the centerline of the above ground target at the correct distance to the invert OR to the top of the pipe.

5. Enter the desired percent grade.
6. Loosen the tripod securing knob, roughly aim the laser to the forward marker at the next manhole and tighten. Depending on the package used, use the red filter sighting scope to find the beam on a target at the forward marker and use the line adjust buttons to get to centerline, or if using the remote control, walk the beam to the forward marker and use the remote to put the beam on the centerline.
7. Dial in the grade on the unit and lay pipe.

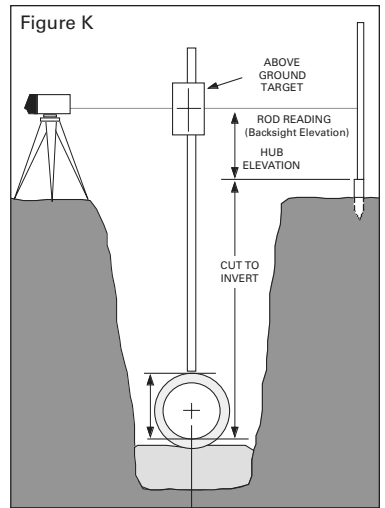

MENU OPTIONS

The user and service personnel can access information through the Set Up Mode. These are the menu selections shown in Step 3 in the next section:

INFO Shows serial number, software version, number of working hours, and service information. There are no values that can be changed.



SETTINGS Three settings can be changed; see instructions later in this section:

- The service interval reminder (CHECK CAL) can be changed from the default of 2000 hrs. to 500 or 1000 hrs.
- When the reminder appears on the screen, it can be turned off (and the counter reset to 0 hours).
- The start-up screen can be changed from "AGL" to your company information.

CALIBRATION See instructions for "Adjusting Level Accuracy" later in the manual.

SERVICE A password is needed by service personnel to access this area.

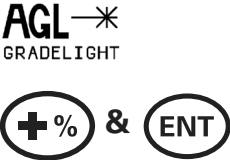
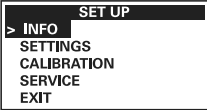
Entering the Set Up Menu

	<p>1. Turn the laser off, and then turn the laser on again.</p> <p>2. When the AGL start-up screen is displayed, press the + and ENT buttons simultaneously. Hold until the Set Up screen appears (after the Battery Check).</p>
	<p>3. The cursor and highlighted text indicate the active menu step.</p>
 <p>Move UP the Menu Move DOWN the Menu</p>	<p>Use the + or - buttons to move up or down the menu. When you reach the desired step, such as CALIBRATION, press ENT.</p>
<p>When you want to leave a menu section, move the cursor to EXIT and press ENT.</p>	

Changing the Service Interval

You can change the interval for the service reminder from the default of 2000 working hrs. to 500 or 1000:

1. Enter the Set Up mode following Steps 1-3 of "Set Up Menu" in previous section.
2. Move down the menu to SETTINGS and press ENT.
3. Go to CAL CHECK TIME and press ENT.
4. In this menu, you can select 500, 1000, or 2000 hrs. The time currently selected will say CAL TIME = XXXX HRS.
5. Use the + or – buttons to select the desired time and press ENT.
6. Go down to EXIT and press ENT. Repeat to leave the Set Up menu.

Deleting the CHECK CAL Reminder

Once the laser reaches the working hours chosen, a reminder will appear on the screen: CHECK CAL. You should be checking the calibration regularly. This is a reminder of operating time intervals. The reminder will appear every time you turn on the laser until you reset the service interval:

1. Enter the Set Up mode following Steps 1-3 of "Set Up Menu" in previous section.
2. Move down the menu to SETTINGS and press ENT.
3. Go to CAL CLEAR and press ENT.
4. TIMER = 0 will be displayed, indicating that the timer is back to zero.
6. Go down to EXIT and press ENT. Repeat to leave the Set Up menu.

Changing AGL Start-up Screen To Your Company Information

If a non-AGL name is already being used, follow Steps 1-2 and 5-8 to change to a different name.

1. Enter the Set Up mode following Steps 1-3 of "Set Up Menu" in previous section.
2. Move down the menu to SETTINGS and press ENT.
3. Go to CUST ID and press ENT.
4. The 1st line will say LOGO = AGL. Move to the 2nd line which says CUST ID and press ENT. It will then display LOGO = CUSTOM ID.
5. Go to BUILD CUST ID and press ENT.
6. Use the arrow keys to move the cursor to the left and right.
 - To move the cursor to the 2nd line, move it to the far right of the 1st line and press the right arrow one more time. This will take you to the 1st character of the 2nd line.
 - You may use this second line for a phone number, abbreviated address, or e-mail.
 - To move back to the 1st line, either press the left arrow or move the cursor all the way to the right and press the right arrow one more time.
7. Texting: once the cursor is where you want it, press the up or down button to scroll through the alphabet and numbers. When the letter you want is displayed, move the cursor to the next character. When you are done, press ENT to save it.
8. Go down to EXIT and press ENT. Repeat to leave the Set Up menu.

TROUBLESHOOTING

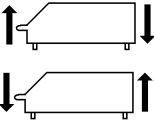
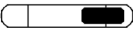
Indication on LCD	Laser Beam	Reason	Remedy
 Blinking	Flashes evenly — — —	Laser is leveling	Wait until self-leveling is completed.
	Pulses in 2 short flashes - - - - -	Self-leveling range is exceeded	Change position of laser in direction arrows indicate. When it's within the self-leveling range, the warning will disappear and self-leveling will begin.
	Pulses in 2 short flashes - - - - -	Cross axis is not level	Rotate laser slightly to the left or right until bubble is between the lines on electronic vial.
CHECK CAL		Reminder that laser has reached 2000 hrs. of use, or the interval set by the user.	The laser can continue to be used. You should be checking the calibration on a regular basis. This is a reminder of operating time intervals. To delete this message, see "Set Up Mode Menu Options."
ERROR 0	No beam; error turns unit off automatically	Data error	Turn laser on again. Check calibration. If the message appears again, contact an authorized service center.

Laser doesn't power-up

- Check battery
- Hold the ON button for at least 3 seconds (if you haven't used the laser in a while).

Loss of distance

- Check window on laser where beam is emitted and clean if needed

Dancing laser spot

- Use a blower to reduce refraction and scintillation problems

Remote control not working

- At longer distances, ensure the remote is in the "line of sight" of the laser. Point remote directly at reception window on GradeLight and remove any obstacles between remote and laser.
- Check and replace batteries
- Operating range is reduced due to rain or fog – use at closer range.
- Operating range is reduced due to dirt on the reception window of the GradeLight – clean with a soft cloth.

Using a Blower to Eliminate Refraction

Certain conditions can cause refraction and scintillation to occur inside the pipe, with the laser dot appearing to be dancing all around the target.

The laser light passes through a medium – air. Anything that disturbs the air will cause the light to scintillate (dance). The two main causes of disturbed air are temperature difference and glue used to connect the pipes.

Before being put in the ground, the pipe lies around the job site in the sun and heat of the day. The pipe is placed into the ground, which is much cooler than the road or dirt surface. The pipe has heated air and will continue to heat the air until it cools off. The turbulent flowing air in the pipe will cause the laser dot to dance.

A solution is to use a blower to move cool air through the pipe. Set the blower at about 5 mph. A dangling dollar bill placed at the outflow end of the pipe will be at a 45° angle in 5 mile per hour of flow – sufficient to cool the pipe in about 20 minutes.

Glue, as it dries, gives off vapors. These vapors are a different density, and possibly different temperature, than the air. This also causes the dancing dot. You will need to wait until the glue is dried enough so that the laser dot is fixed for a good reading.



OPTIONAL EQUIPMENT

Blower for Refraction Control

Minimizes laser drift for long pipe runs where there is more than a 20° F temperature difference between the trench top and bottom. P/N 1-08915

Target Panel

For 12" and 15" (300-400mm) pipe. Can be used with standard frame. P/N 1-11254

Large Target Assembly

For 15" (375mm) and larger pipe. P/N 1-11217

Tall Leg Set

For 15" to 24" pipe:

Order 2 side legs (9-09622) and 1 center leg (9-09623).

Metric, for 375-600mm pipe:

Order 2 side legs (9-09606) and 1 center leg (9-09607).

Optical Instruments for Checking Elevation

Digital Level and Bar Code Rod

One push of a button provides digital elevation and distance. Eliminates rod reading errors. P/N 1-16612

AL26-C Automatic Level

High accuracy, wire hung magnetic compensator with 26X magnification. P/N 1-16613

CHECKING & CALIBRATION

THIS CHAPTER IS VERY IMPORTANT. Here are a few simple instructions to check your GradeLight for calibration. Remember that the laser is a precision instrument and that it is important that you keep it calibrated and in proper condition. The accuracy of your work is completely your responsibility and you should check your instrument before beginning each job, and especially after the instrument has taken a sharp jolt or been dropped, or when temperature changes greater than 50 degrees F (28 degrees C) have occurred.

Checking Level Accuracy

Select a reasonably level area. Set up the GradeLight on a stable surface. The cross axis vial should be centered and the legs adjusted so the unit is level.

It will be easier to adjust the laser to strike stake B in Figure 1 if you use the single centerline leg in the front (beam side) or if you use a trivet with height adjustable rod.

After the unit has self-leveled, set the grade at 0.000%.

Fig. 1

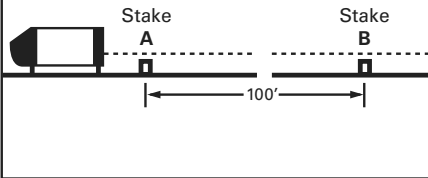

1. Establish two benchmarks:

Figure 1: Drive two stakes (A & B) in line with the laser beam, but low enough for the beam to pass over both stakes. Stake A should be about 1' (.3m) from the unit, and stake B about 100' (30m) away.

2. Check the instrument:

A. Figure 2: Place a short 2x4 or something similar on stake A, and mark where the center of the beam strikes. Call this mark A1.

B. Place the same 2x4 on stake B and again mark where the center of the beam strikes. Call this mark B.

Fig. 2

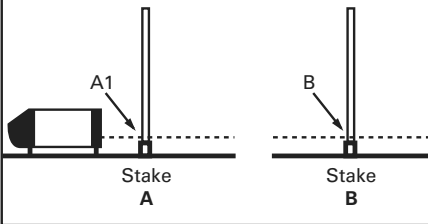

3. Move the laser to the far side of stake B (Figure 3) so the beam will cross over both stakes as before, but in reverse order.

A. Be sure the height of the unit is set so that when the 2x4 is placed on stake B, the beam will strike at mark B.

B. Now place the 2x4 on stake A. Make a second mark (A2) where the center of the beam strikes.

Fig. 3

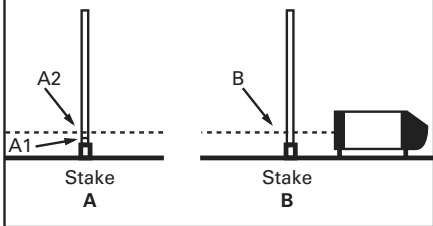

At 100 ft., the marks should be no more than 1/8" apart (at 30m, no more than 3 mm apart). This is within the stated accuracy of $\pm 1/16''$ at 100 ft.

If the marks are close enough, the beam is accurately projecting level. If they are not close enough, take it to an authorized AGL service center for calibration, or adjust the unit using the following procedure.

Adjusting Level Accuracy (Calibration)





Without moving your checking setup, make a mark on the 2x4 halfway between A1 and A2 (call it C). The laser must be calibrated to bring the beam to the center mark C.

Important: Before calibrating, ensure that the instrument housing is level by placing a small carpenter's level on top of the unit, parallel with the beam. Do not move the unit; only adjust the single centerline leg until the housing is level.

Do not enter calibration mode or attempt adjustment unless you plan to change the accuracy. Accuracy adjustment should be performed carefully, by someone who understands basic adjustment principles.

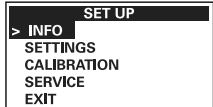
If you've made changes you don't wish to save, turn the laser off.

Accessing Calibration through the Set Up Menu

	<ol style="list-style-type: none">1. Turn the laser off, and then turn the laser on again.2. When the AGL start-up screen is displayed, press the + and ENT buttons simultaneously. Hold until the Set Up screen appears (after the Battery Check).
	The cursor and highlighted text indicate the active menu step.
 <p>Move UP the Menu Move DOWN the Menu</p>	Use the + or - buttons to move up or down the menu. Move down to CALIBRATION and press ENT.
	Confirm the step MAIN AXIS by pressing ENT.
<p>WAIT</p>	The screen will show WAIT.
<p>SET</p>	<p>When SET appears, the height of the laser beam can be adjusted to the center point C.</p> <p>Do this using the remote, so that you do not disturb the unit during adjustment. It will also allow you to stand at stake A and move the beam until it is at C.</p>
 <p>Move Beam UP Move Beam DOWN</p>	Use the Center Line Button on the remote to move the beam up; use the Standby (ZZZ) Button on the remote to move the beam down.
<p>SET</p>	After a change, check the laser LCD and wait until SET appears again on the screen, and move the beam again if needed.

— continued on next page



To save the calibration (beam position), press the lock button on the remote (or the ENT button on the laser keypad).

If you don't want to save the calibration, turn the laser off.



To leave the CALIBRATION mode, move the cursor to EXIT and press ENT.

(If you are using the remote, move up the menu using the Center Line Button and move down the menu using the Standby (ZZZ) Button. Press the lock button instead of ENT.)

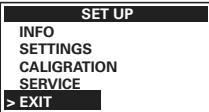

To leave the SET UP mode, move the cursor to EXIT and press ENT.

Final Calibration Check

Re-check your new calibration using the steps shown in the previous section with Stakes A and B. If the marks are no more than 1/8" apart (at 30m, no more than 3 mm apart), the laser is within the accuracy spec and calibrated correctly.

SAFETY, CARE, AND HANDLING

Caution

Use of controls or adjustments or performance of procedures other than those specified herein may result in hazardous radiation exposure.

There is a purge screw inside the battery cavity, under a black decal. **DO NOT OPEN!** If this screw is removed, the moisture-free nitrogen purge of the unit will be lost.

Service

To avoid possible exposure to radiation in excess of acceptable emission limits, all repairs requiring the opening of the sealed laser case must be performed by the manufacturer or its authorized representative.

Limits of Use

CE-marking (European regulation):

The instrument, including accessories, complies with the regulations of permission for low voltage and electromagnetic compatibility.

Attention: This instrument contains lithium-ion batteries. Lithium-ion batteries must be recycled or disposed properly.



Danger: The use in an aggressive or explosive environment (especially gas bearing pipes) is strictly prohibited.



Warning: Never short circuit the battery contacts with any metal parts or hold the battery under water. In case of a short circuit the battery can get extremely hot and there is a risk of injury and fire.



Warning: Never try to charge the battery with chargers that are not supplied from the manufacturer.

Care and Handling

1. The GradeLight is a precision instrument that must be handled with care. Avoid shock and vibrations.
2. After use, it's recommended that you wipe the laser dry and store in a dry place. Do not store the laser in its case if the laser or the case are wet.
3. Remove the battery from the product for storage.
4. Do not store the laser at temperatures below -40° F (-40° C) or above 140° F (+60° C).
5. To maintain the precision of your laser, check accuracy regularly and adjust if necessary.
6. Use a soft cloth, moistened if necessary, to clean the LCD and the window on the laser for the beam output and remote reception. Do not clean plastic windows or painted surfaces with acetone.

WARRANTY

EXPRESS WARRANTY FOR HARDWARE. AGL Corporation (“AGL”) warrants to the original end user (“Customer”) that this Product will be free from defects in workmanship and materials, under normal use, for one (1) year and non-AGL-manufactured products for which ninety (90) days shall apply, unless such warranty period has been extended by AGL, and provided any and all operating and maintenance instructions are strictly respected, in particular in case of extreme and/or continuous applications/use of the Product. The warranty period begins on the proved purchase date, or if applicable, date of delivery or date of acceptance report. AGL’s sole obligation under this express warranty shall be, at AGL’s sole option and expense, to replace or repair the Product or part, or refund the purchase price paid for the Product. AGL warrants any repaired or replaced Product or part for a period of ninety (90) days from shipment, or through the end of the original warranty, whichever is longer. All Products or parts that are replaced become the property of AGL. This express warranty does neither cover consumables, such as batteries, bulbs and fuses, nor third party products.

OBTAINING WARRANTY SERVICE. Customer must contact an authorized service center of AGL or AGL’s Service Center within the applicable warranty period to obtain warranty service authorization. Dated proof of original purchase from AGL’s authorized distributor and a description of the defect will be required. AGL is not responsible for Products or parts received without a warranty service authorization. Repaired or replacement Products will be shipped to Customer at AGL’s expense. The repaired product or part will be shipped as soon as reasonably possible. AGL shall not be responsible for any damages occurring during such shipment. For Products forming part of a fixed installation, such place of performance shall be the site of such installation and AGL shall have the right to charge for additional costs for such services under warranty if the site of the Product is other than where the Product was originally shipped or installed.

WARRANTY EXCLUSIVE. Customer’s sole remedy for breach of the warranty shall be the express warranty. The foregoing warranty is exclusive and is in lieu of all other warranties, terms, or conditions, express or implied, either in fact or by operation of law, statutory or otherwise, including warranties, terms or conditions of merchantability, fitness for a particular purpose, satisfactory quality and non-infringement, all of which are expressly disclaimed. AGL shall not be liable if the alleged defect or malfunction was caused by Customer’s or any other person’s misuse, neglect, improper installation, unauthorized attempts to open, repair or modify the Product, inadequate maintenance, disregard of operating instructions, excessive load or stress, normal wear and tear, or any other cause beyond the range of its intended use, by accident, fire, or other hazards, or other cause not due or attributable to AGL. This warranty does not cover physical damage to the Product or malfunctions resulting from the use of the Product in conjunction with any sort of ancillary or peripheral equipment and AGL determines that there is no fault with the Product itself.

LIMITATION OF LIABILITY. AGL also excludes any liability, whether based on contract or tort (including negligence), for incidental, consequential, indirect, special, or punitive damages of any kind, or costs of procurement of substitute products by customer, or for the loss of revenue or profits, loss of business, loss of information or data, or other information or financial loss arising out of or in consequence with the sale, installation, maintenance, use, performance, failure, or interruption of this product, even if AGL or its distributors have been advised of the possibility of such damages, and limits its liability to replacement, repair, or refund of the purchase price paid, at AGL’s option. This limitation of liability for damages will not be affected if any remedy provided herein shall fail of its essential purpose.

DISCLAIMER. Should a court of jurisdiction not allow the entire exclusion or limitation of implied warranties or the limitation of incidental or consequential damages for certain products supplied to Customers, or the limitation of liability for personal injury, such implied warranties and such liabilities will be limited to the duration of the applicable express warranty.

With this Limited Warranty, AGL grants Customer specific legal rights which do not restrict any statutory consumer rights. This Limited Warranty shall be governed by the laws of Arkansas, USA.



AGL
DECLARATION OF CONFORMITY

MANUFACTURER: AGL CORPORATION
ADDRESS: 2202 REDMOND ROAD
JACKSONVILLE, ARKANSAS 72076 USA

declares that the product

APPARATUS: LEVELING LASER
MODEL NUMBERS: GL2700
EQUIPMENT TYPE: INDUSTRIAL

conforms to the following Product Specifications:

SAFETY: IEC/EN 61010-1:2ND ed. (2001)
EMC: EN 55011: 2007, Class A, Group 1
EN 61000-3-2: 2006
EN 61000-3-3: 1995 + A1 (2001) + A2 (2006)

YEAR CE MARK AFFIXED: 2008

DATE OF ISSUE: 05 NOVEMBER 2008

PLACE OF ISSUE: JACKSONVILLE, ARKANSAS USA

AUTHORIZED SIGNATURE:

AGL CORPORATION

JENNIFER FAIRCHILD
DIRECTOR, Product Development and Quality

This product was tested in a typical configuration by: Nemko Canada, Inc.
303 River Road, RR#5
Ottawa, Ontario, Canada K1V 1H2

EMC Integrity Incorporated
1736 Vista Drive
Longmount, Colorado, USA 80504

2202 Redmond Rd. Jacksonville, AR. 72076 Phone: 501.982.4433 Fax: 501.982.0880 www.agl-lasers.com



2202 Redmond Rd., Jacksonville, AR 72076
sales@agl-lasers.com www.agl-lasers.com
Phone: 501.982.4433 Fax: 501.982.0880
Toll Free: 800.643.9696